

# **OPERATING MANUAL**

---

## **TANDEM-PLATFORM TANDEM-BOX**

---



# Contents

<b>1</b>	<b>Identification</b>	<b>5</b>
<b>2</b>	<b>Product description</b>	<b>6</b>
<b>3</b>	<b>Intended use</b>	<b>9</b>
<b>4</b>	<b>Use contrary to the intended</b>	<b>9</b>
<b>5</b>	<b>General safety information</b>	<b>9</b>
<b>6</b>	<b>How does the brake system works?</b>	<b>13</b>
6.1	Service brake	13
6.2	Handbrake	13
6.3	Spring brake-emergency release	14
<b>7</b>	<b>How does the pneumatic suspension works? ( HT 10xxxx and HT 11xxxx trailers)</b>	<b>14</b>
7.1	Lifting the trailer using the pneumatic suspension	15
7.2	Lowering the trailer using the pneumatic suspension	15
7.3	Setting the trailer in the driving position	15
<b>8</b>	<b>How do I couple and connect the trailer to my vehicle?</b>	<b>16</b>
8.1	Setting the drawbar at the coupling height of the towing vehicle ( HT up to 11,9t)	16
8.2	Extension and retraction of the jockey wheel or the supporting base	16
7.3	Coupling the trailer	16
<b>9</b>	<b>How do I couple and secure the trailer?</b>	<b>17</b>
<b>10</b>	<b>How do I load and unload the trailer?</b>	<b>17</b>
10.1	Load distribution	18
10.2	Load protection	18
10.3	Lowering/Lifting the supporting base	19
10.4	Handling the sidewalls	19
10.5	Handling the box structure	20
10.7	Unloading the trailer	20
10.8	Handling the underrun protection	21
<b>11</b>	<b>How do I maintain the trailer ?</b>	<b>21</b>
<b>12</b>	<b>How do I service the trailer?</b>	<b>23</b>
12.1	Maintenance regime	23
12.2	Axle	24
12.3	Towing ring	24
12.4	Lubrication of the drawbar	24
12.5	Lubrication of the folding legs	24
11.6	Lubrication of the supporting base	24
12.6	Maintenance of the compressed air system	25
12.7	Tightening torque	25
12.8	Tyres	26
12.10	Plug connection	27
12.11	Changing the lights	28

<b>13</b>	<b>Accessories</b>	<b>29</b>
13.1	Duomatic-coupling	29
13.2	Night park warning signs	30
13.3	Spare wheel holder	31
13.4	Fire extinguisher box	33
13.5	Plastic toolbox	34
13.6	Cutainsider Structure	35
13.7	Tarp and hoop	41
<b>14</b>	<b>How do I dispose of the trailer or parts of the trailer?</b>	<b>44</b>
<b>15</b>	<b>What should I do in the event of a malfunction?</b>	<b>45</b>
<b>16</b>	<b>Service and Warranty policy</b>	<b>47</b>

# 1 Identification

**Product name:** Tandem Platform HT (Humbaur Tandem)

There are 12 different types of HT trailers:

## Type 1

Type designation: HT 504124

## Type 2

Type designation: HT 505124

## Type 3

Type designation: HT 506124

## Type 4

Type designation: HT 507124

## Type 5

Type designation: HT 504024-20S

## Type 6

Type designation: HT 505024-20S

## Type 7

Type designation: HT 506024-20S

## Type 8

Type designation: HT 105224

## Type 9

Type designation: HT 106224

## Type 10

Type designation: HT 107224

## Type 11

Type designation: HT 116224

## Type 12

Type designation: HT 117224

For special vehicles deviations in box dimensions are possible.

### Name and address of manufacturer:

Humbaur GmbH  
Mercedesring 1  
Germany-86368 Gersthofen  
Tel. 0049/ (0)821/24929-0  
Fax 0049/(0)821/249-100

### Name and address of dealer:

Name: \_\_\_\_\_

Address: \_\_\_\_\_

\_\_\_\_\_

Telephone: \_\_\_\_\_

## 2 Product description

The HT (Humbaur tandem) trailers are available in four different models. Three models for the tandem platform, HT 50xxxx, HT 10xxxx and HT 11xxxx. And the other model is the tandem box trailer HT 50xxxx-20S.

The tandem trailers are designed to be attached to a towing vehicle.

The trailer has anodized aluminium sidewalls with locks. The load can be lashed in the lashing shackles that are placed over the entire length of the trailer. The trailer with 5 tonnes allowed total weight has maintenance free due to the rubber spring axle. The trailer has an air brake with ABS, ALB controller and spindle handbrake. The connection to the towing vehicle is realized with an adjustable height towing device and a towing ring.

The box trailers HT 50xxxx-20S have folding doors. These can be closed using the door locking gears.

The trailers with a allowed total weight up to 11.9 tonnes have an air system brake with EBS and spring brake.

Further, the trailers are equipped with a pneumatic suspension which adjusts the driving height depending on the load.

The bridge floor is resilient to DIN EN 283. The connection to the towing vehicle is realized with an adjustable height towing device and a towing ring, which is adjustable with a crank.

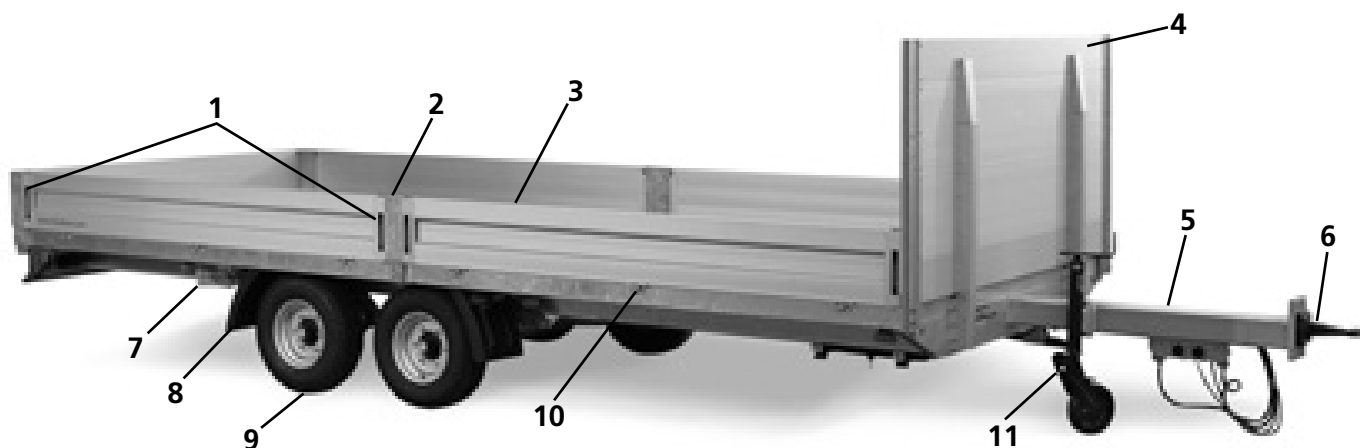

HT 50xxxx Tandem-platform

- |                  |                   |
|------------------|-------------------|
| 1 Sidewall locks | 7 Wheel chocks    |
| 2 Side posts     | 8 Fender          |
| 3 Sidewall       | 9 Tyres           |
| 4 Front wall     | 10 Sidewall hinge |
| 5 Drawbar        | 11 Jockey wheel   |
| 6 Towing ring    |                   |



HT 50xxxx front wall

- 1 Electrical plug(15-pin)
- 2 Interchangeable pneumatic brake heads
- 3 Crank for spindle handbrake



**HT Tandem box trailer**

- |   |                  |   |              |
|---|------------------|---|--------------|
| 1 | Box body         | 5 | Wheel chock  |
| 2 | Drawbar          | 6 | Tyres        |
| 3 | Towing ring      | 7 | Fender       |
| 4 | Door check strap | 8 | Jockey wheel |

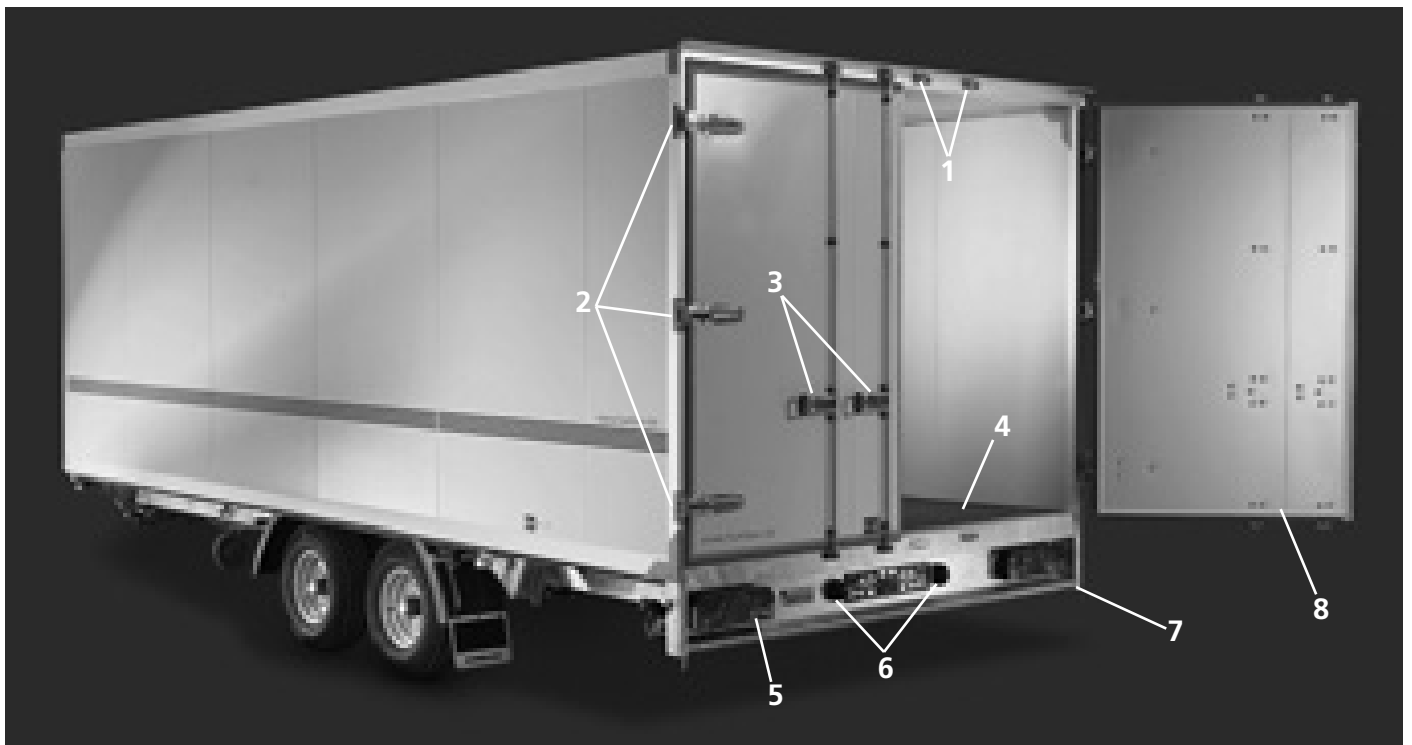

**HT Tandem box trailer rear view**

- |   |                   |   |                     |
|---|-------------------|---|---------------------|
| 1 | Locks of the door | 5 | Rear lights         |
| 2 | Door hinges       | 6 | License plate light |
| 3 | Door locking gear | 7 | Underrun protection |
| 4 | Loading area      | 8 | Folding door        |

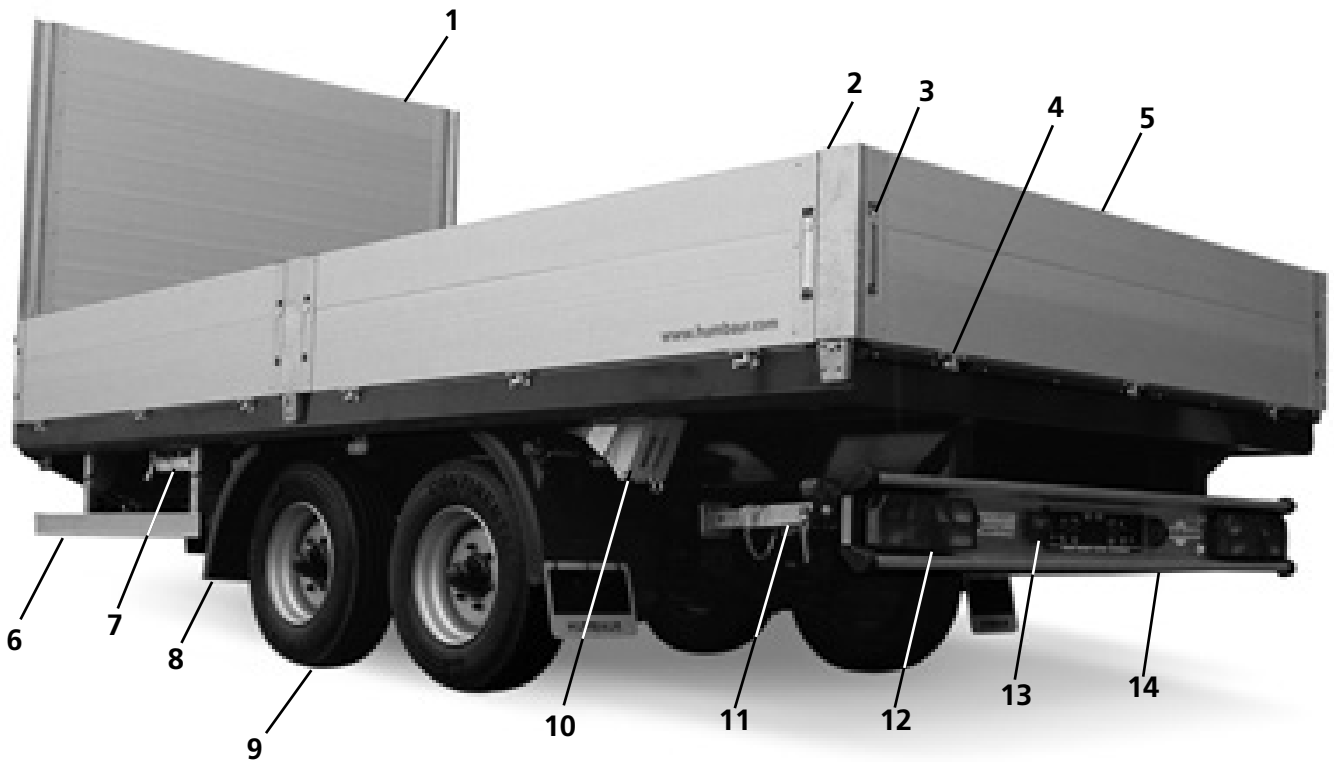

HT 10xxxx and HT 11xxxx Tandem-Platform up to 11,9 rear view

- |  |                        |
|--|------------------------|
| 1 Frontwall                                  | 8 Fender               |
| 2 Side posts                                 | 9 Tyre                 |
| 3 Sidewall locks                             | 10 Wheel chock         |
| 4 Sidewall hinge                             | 11 Case support        |
| 5 Sidewall                                   | 12 Rear lights         |
| 6 Folding underrun protection                | 13 License plate light |
| 7 Control panel for the pneumatic suspension | 14 Underrun protection |

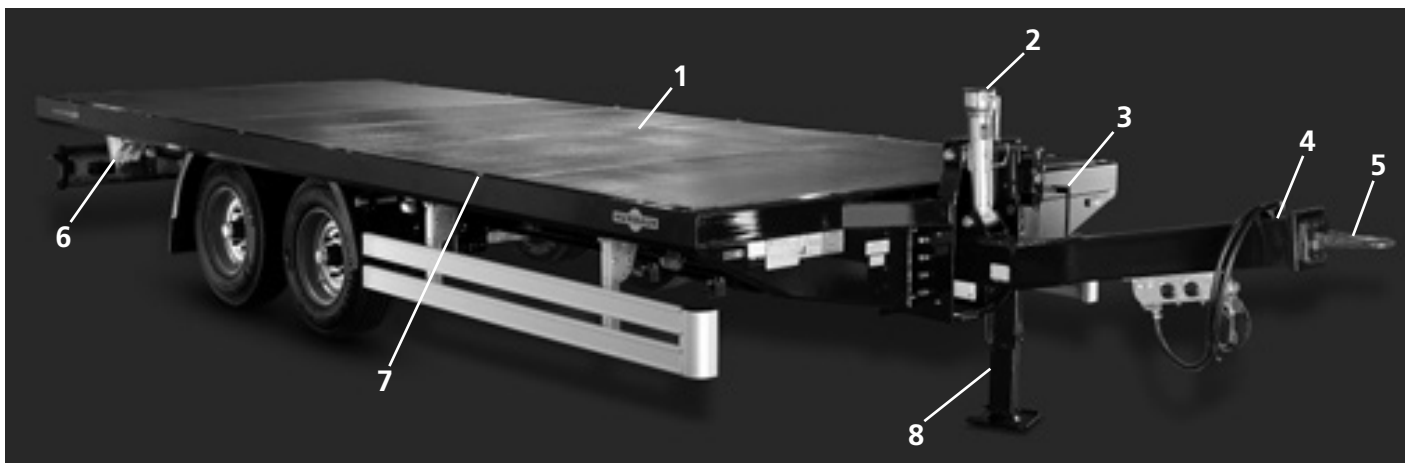

HT 10xxxx und 11xxxx Tandem-platform up to 11,9 tons front view

- |                                 |
|---------------------------------|
| 1 Loading board                 |
| 2 Drawbar height adjustment     |
| 3 Crank for the supporting base |
| 4 Drawbar                       |
| 5 Towing ring                   |
| 6 Wheel chock                   |
| 7 Lashing shackle               |
| 8 Supporting base               |



### 3 Intended use

The next description applies for HT 50xxxx, HT 50xxxx-20S, HT 10xxxx and HT 11xxx trailers.

The trailers are designed to be attached to a permissible towing. They must be loaded within the permissible total weight. Transporting dangerous goods, like chemical materials, is not allowed. A steady weight distribution must be possible through the load. When loading a single load this one must have a uniform distribution. The driver is responsible for the load and their protection. The driver has to follow the respective country specific laws for the load. To optimise the braking efficiency, the braking tuning must be performed after 2000 to 5000 km, and after every change of the towing vehicle.

Trailers must be used only in a technically flawless state

### 4 Use contrary to the intended

The following are considered to be contrary to the intended use for all models of the Tandem HT series:

- Load with a high payload.
- Transport persons on the trailer.
- Drive with unsecured loads.
- Unapproved structural changes to the trailer.
- Exceeding the support and trailer load.
- Transporting hot materials (e.g. Tar).

### 5 General safety information

The safety information is valid for all HT trailers

#### Danger to life!



**Danger!**

Couple and uncouple the air pressure heads.

If the order is swapped, the brake and the trailer release the brakes. The trailer can roll. This can lead to fatal accidents.

**Be sure to connect the air pressure heads correctly.**

#### Danger to life!



**Danger!**

on an area with strong slope. The trailer is perpendicular to the slope. The focus of the load shifted out of the center.

The trailer can tip over.

**Do not load the trailer perpendicular to the slope.**

#### Danger to life!



**Danger!**

Loading the trailer in the uncoupled state, without lowering the supporting base.

The supporting base at the rear of the trailer is not folded down for loaded and unloaded. The trailer can tilt over. People can be injured or killed, things could be damaged.

**Fold the supporting base down to load and unloaded in the uncoupled state.**

#### Danger to life!



**Danger!**

Driving with the supporting base down.

The supporting base can tear down in the journey and fly around uncontrollably. This can lead to accidents. People can be injured or killed.

**Make sure the supporting base is always folded up before the journey begins.**

#### Danger to life!



**Danger!**

Securing the load with the lashing shackles or the lashing rings.

The allowable strength of the lashing shackles or the rings is exceeded. It can not hold the load and breakdown. This can cause accidents. People can be injured or killed. Objects could be damaged.

**Do not exceed the allowable strength of the lashing shackles or rings.**

#### Danger to life!



**Danger!**

Engage the trailer to the towing vehicle.

Engage the trailer to the towing vehicle. Since the trailer doesn't have a handbrake and can not be controlled, this can lead to accidents. People can be injured or killed, objects could be damaged.

**Coupling the towing vehicle to the trailer. Never vice versa.**

#### Danger to life!



**Danger!**

Coupling the trailer to the towing vehicle with a position adapter.

The position adapter stands between the towing vehicle and the trailer. He can be run over.

**Instruct the position adapter to never stand between the towing vehicle and the trailer.**

### **Danger to life!**



**Danger!**

Electrical system disconnected.  
The lighting at the rear does not work.  
Other road users may not recognize when the trailer brakes. In the dark other road users can not see the trailer. This can lead to injuries up to death.  
**Check before every ride that the electric system is connected and**

**the lights are working properly.**

### **Danger to life!**



**Danger!**

Drive with the compressed air unconnected.  
The trailer can not brake. This can lead to injuries up to death.  
**Check the connections before each journey.**

### **Danger to life!**



**Danger!**

Driving with unsecured loads.  
The load or load parts can be thrown outwards the trailer. People can be injured or killed.  
**Secure the load in every journey.**

### **Danger to life!**



**Danger!**

Driving with a wrong load distribution.  
The axles are unevenly loaded and can be damaged. This can lead to accidents.  
**Distribute the load for the journey according to the valid laws and regulations.**

### **Danger to life!**



**Danger!**

Drive on an extreme sloping situation.  
The trailer can tip over. If the trailer is loaded, the danger increases, because the main focus of the load moves upwards.  
**Do not drive across the slope.**

### **Danger to life!**



Driving with unventilated air suspension bellows.

The axles are unevenly loaded and can be damaged. This can lead to accidents.

**Before departure, make sure that the air suspension bellows are ventilated.**

### **Danger to life!**



**Danger!**

Drive with uncouple hitch or wrong coupled.  
The hitch will open during the journey and the trailers will be uncoupled. The supply lines break off and the trailer makes a full braking. This can lead to accidents.  
**Check the coupling; be sure that the hitch is properly closed.**

### **Danger to life!**



**Danger!**

Drive with defective tyres or with high pressure.  
The tyres burst during the ride and the trailer starts to roll. This can lead to accidents.  
**Check the tyres like the chapter of maintenance describe.**

### **Danger to life!**



**Danger!**

Drive at excessive speed.  
The trailer can skidding and causes the towing vehicle skid too. This could cause personal injuries, death or property damage.  
**Drive according the valid laws and regulations about the speed limits in the country.**

### **Danger to life!**



**Danger!**

Drawbar or towing ring damaged.  
The damage has to be repair, because these components are highly loaded, do not load in this condition because the components could breakdown.  
**Replace any damaged drawbar or towing ring for new ones. Welding and changes in the structure are not allowed.**

### **Danger to life!**



**Danger!**

Drive with dirty filter of the compressed air lines.  
This may lead to failures in the braking system and to fatal accidents.  
**Clean the filter according to the maintenance instructions.**

Enter to the loading area with inappropriate footwear.  
The loading area can be slippery with soiling or moisture. The person can be injured.  
**Enter the trailer only with adequate footwear.**

### Danger to life!



**Danger!**

Adjusting the side underrun protection. The underrun protection is not adjusted or is defective. In an accident, it doesn't fulfil the purpose any more, people can be injured.  
**Make sure the underrun protection is mounted in the required position and has not damage**



**Caution!**

**Retighten the wheel nuts after the first journey, the first 50 km, or after a wheel change. Check regularly that the wheel nuts are tight.**

### Danger to life!



**Danger!**

Securing the wheel chocks under the loading area.  
The wheel chocks under the loading area are not properly secured. The wheel chocks may become loose during the journey and flung through the air. This can lead to accidents. People can be injured or killed, objects could be damaged.  
**Secure the wheel chocks for every journey.**

### Additional safety information for HT 50xxxx-20S:

#### Danger to life!!



**Danger!**

Driving with the double folding doors open  
Load can get lost during the journey or the immersive air flow makes the trailer spin. This can lead to accidents. People can be injured or killed, objects could be damaged.  
**Close the double hinged doors properly for every journey.**

### Risk of injury!



**Caution!**

Working in the electrical system.  
The power supply was not ceased. The person touches the wires. This can injure the person.  
**Disconnect the power supply from the towing vehicle when you are working with the electrical system.**

#### Danger to life!



**Danger!**

Closing the double folding doors.  
The doors are not properly secured for the journey. The vibrations during the journey could open the doors and turn them independently. This may cause accidents. People can be injured or killed, objects could be damaged.  
**Close the double folding doors properly for every journey.**

### Risk of injury!



**Slip  
Danger!**

Climb on the drawbar.  
The drawbar works under the additional load down. This can lead to the loss of balance and to injuries.  
**Do not climb on the drawbar.**

### Risk of injury!



**Achtung!**

**Risk of injury!**

Opening and closing the folding doors. The fingers can be crushed between the door and the box body when you open or close the doors.

**Take care when operates the double doors that you do not crimp their fingers.**

### **Risk of injury!**



**Danger!**

Open the double doors. When you open the double doors people can be injured or objects can be damaged.

**Make sure that there aren't people or objects in the pivot area when you open the double doors.**

### **Risk of injury!**



**Caution!**

Open the double doors when the trailer is loaded.

The double doors can jump up by the pressure which is exerted by the load and this can fall down.

**Open the double doors carefully when the load is against the doors.**

**Additional safety information for tandem platform HT up to 11.9 ton:**

### **Danger to life!**



**Danger!**

Driving with unplugged EBS cable. The brakes brake under full load. This can lead to accidents, people could injure or killed.

**Check the connector before each journey.**

### **Danger to life!**



Driving with unventilated air suspension bellows.

The axles are unevenly loaded and can be damaged. This can lead to accidents.

**Before departure, make sure that the air suspension bellows are ventilated.**



**Danger!**

### **Danger to life!**

Adjust the drawbar height.

The height of the drawbar is not adjusted to the wheel height of the towing vehicle. The trailer is in a tilted position. This can lead to accidents. People can be injured or killed, objects could be damaged.

**Adjust the drawbar height to the towing vehicle height.**

### **Danger to life!**



**Danger!**

Securing the crank of the drawbar and the supporting base.

The crank is not secured for the journey. The supporting base can fall during the journey down. The drawbar can rise or fall, causing tension in the coupling. This can lead to accidents. People can be injured or killed, objects could be damaged.

**Secure the crank and the supporting base of the drawbar for each journey.**

### **Material damage!**



**Caution!**

Activating the handbrake when the brake is overheated.

The brake discs can be damaged by the different cooling rates that occur in the braking process. At high temperatures the disc brakes expand slightly and press the brakes pad harder. When the brake is released, the pads could present irreparable damages.

**Activate the handbrake when the brake is cold.**

## 6 How does the brake system works?

You must realize a braking tuning every time you change the towing vehicle and after 2000 to 5000 km. This ensures that the braking powers is optimally and the brake pad wear is minimized.

The brake has an EBS or ABS module. Faults and damages are detected in the braking system and warning lights are displayed in the towing vehicle.

There are two different stages.

1. The yellow warning lamp lights up.

The system has detected an error, which is not serious.

You should visit the garage when the yellow warning lamp appears.

2. The red warning lamp lights up.

The system has discovered a serious mistake. Stop immediately and let a breakdown service come. Journeys in this state are not allowed, because the brake assembly is not functional any more.

If the warning lamps already indicate a mistake while starting the vehicle, drive at low speed a few metres. If the warning lamps do not go out, visit a garage if is yellow or stop the car in case is red.



Brake control panel for trailers with pneumatic suspension

- 1 Swing lever for pneumatic suspension
- 2 Spring brake
- 3 Service brake

### 6.1 Service brake

The service brake is automatically activated when the supply line from the towing vehicle is disconnecting. To solve this, you must press the black button on the control panel. The service brake will be activated by hand, pulling the knob.

The pressure in the system drops repeatedly by activating and releasing the brake. If it falls below 3 bar the service brake can not be activated.

### 6.2 Handbrake

#### Danger to life!



Handbrake.

The spring brake is released and the trailer rolls off. This can cause injuries and even death.

**Secure the trailer with the wheel chocks.**

#### Danger!

#### Spindel handbrake

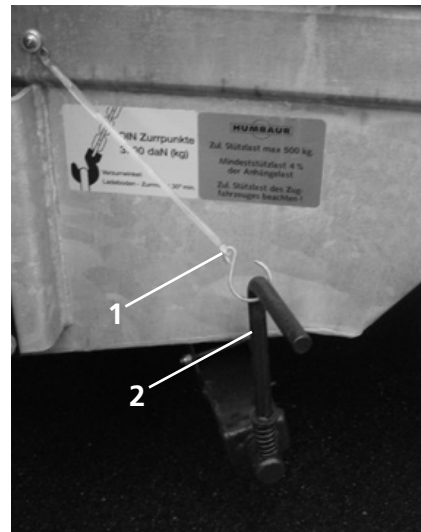

Crank of the spindle handbrake

- 1 Safety cord of the crank
- 2 Crank of the spindle handbrake

The trailers HT 50xxxx und HT 50xxxx-20S are equipped with a standard spindle handbrake. To operate this you should take off the safety cord of the crank. Turn the crank clockwise until the brake is tight. To release the handbrake, turn it counter clockwise until it stops. Insert the safety cord in the crank.

#### Spring cylinder

The HT 10xxxx und HT 11xxxx are equipped with a spring parking brake. Press the spring brake when it is cooled. You activate this by pulling the red button on the control panel until it snaps into place. To release it press the same button. The pressure in the system drops repeatedly by pressing and releasing the brake. If it falls below 5.2 bar, the spring brake can not be activated on the control panel.

### 6.3 Spring brake-emergency release

If you need to release the spring-loaded brake, although the pressure in the reservoir is lower than 5.2 bar, you can do it using the emergency release.

The HTD is equipped with four spring brakes (two in the rear axles). You will have to release them individually.

#### Releasing the spring loaded brake

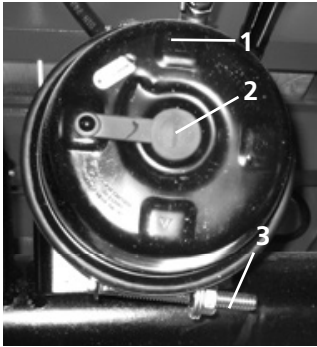

Spring loaded brake- emergency release

- 1 Brake cylinder
- 2 Protection cap
- 3 Threaded bolt

#### Danger to life!



**Danger!**

The trailer brake is activated when the trailer brake valve is out of function.

The trailer can run over people and also cause property damage.

**The trailer brake valve needs to be deactivated before driving with the trailer.**

Place the wheel chocks. Open the protection cap on the spring. Rotate it to the side. Loosen the nut (wrench size 24) on the threaded bolt. Remove the bolts from the bracket.

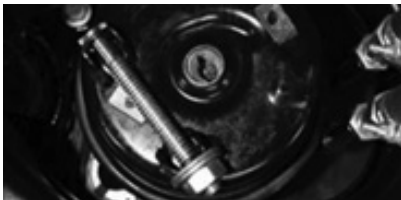

Opening the spring brake

Put the loose thread bolt with the profile at the end of the opening in the spring brake. Turn the thread bolt around approximately 90°. Put the washer and the nut on the thread bolt and tighten them up to the case of the spring brake.



Spring brake with screw wrench

Now using the screw wrench you can turn completely the threaded rod from the housing and rotate it to release the spring.

You must perform this operation on all spring brakes. Deactivate the emergency release before the journey and before you put the pressure on the handbrake back.

#### Resetting the emergency release

If the operating pressure of the trailer reaches at least 5.2 bar, you will need to unscrew the threaded bolts in all the spring brakes and remove them.

Place the threaded bolts back on the housing of the spring brake and then secure them properly. Close the assembly with the protection cap.

The emergency release brake is deactivated and the trailer can be braked with the spring-loaded brake.

## 7 How does the pneumatic suspension works? ( HT 10xxxx and HT 11xxxx trailers)



Brake control panel for trailers with pneumatic suspension

- 1 Swing lever for pneumatic suspension
- 2 Spring brake
- 3 Service brake

## Danger to life!



**Danger!**

Driving with the swing lever not placed in the driving position.

The trailer can fling during the journey or throw parts of the trailer out. This can lead to accidents. People can be injured or killed, objects could be damaged.

**Place the swing lever in the "driving position" before each journey.**

## Danger to life!



**Danger!**

Swing lever not placed in the driving position.

Driving with higher air pressure can lead to exceed the maximum allowable height. This can lead to accidents. People can be injured or killed, objects could be damaged.

**Set the swing lever in the "driving position" before every journey.**

All Humbaaur tandem Platform and trailers from the series 10xxxx Ht and 11xxxx are equipped with a pneumatic suspension. With the pneumatic suspension, the driving position always has the same height regardless of the different loads. The control lever of the pneumatic suspension is located on the control panel on the left, under the loading area. With the pneumatic suspension the lever of the trailer can be adapted for loading and unloading.

The lift and lower valve is equipped with a security function called "stop position". Make sure that you release the handbrake before you lift or lower the trailer.

## 7.1 Lifting the trailer using the pneumatic suspension

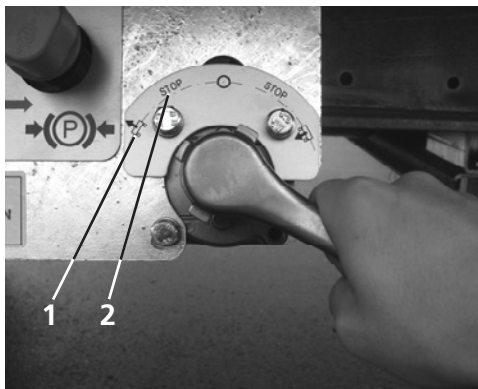

Swing lever in "Lifting" position

- 1 Position "Lift"
- 2 Position "Stop"

To lift the trailer, press the lever inwards and turn it counter-clockwise on the symbol "lift". The trailer is lifting.

If the desired height is reached, turn the lever to the "stop" position. The trailer will remain in that position.

## 7.2 Lowering the trailer using the pneumatic suspension

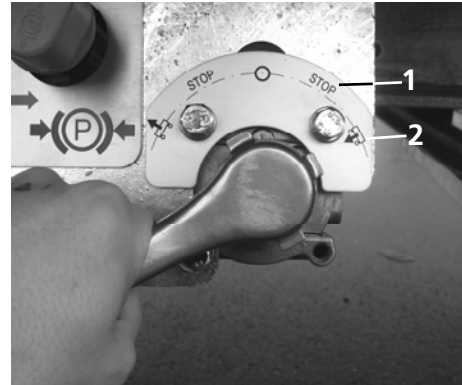

Swing lever in "stop" position

- 1 Position "Stop"
- 2 Position "Lower"

To lower the trailer, press the lever inward and turn it clockwise on the symbol "lower". The trailer starts to lower. If the desired height is reached, turn the lever to the "stop" position. The trailer will remain in that position.

## 7.3 Setting the trailer in the driving position

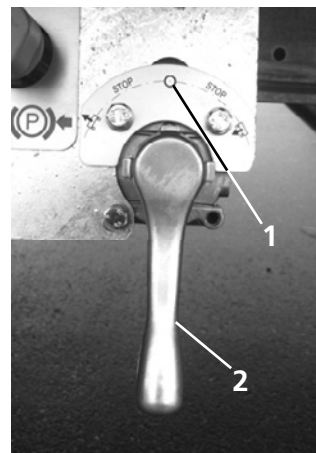

Swing lever in driving position

- 1 Driving position
- 2 Swing lever

If the swing lever stands in the driving position, this is pulled out and can not be swung. In this position the trailer can be driven.

Set the swing lever in the driving position before every journey.

## 8 How do I couple and connect the trailer to my vehicle?

### 8.1 Setting the drawbar at the coupling height of the towing vehicle ( HT up to 11,9t)

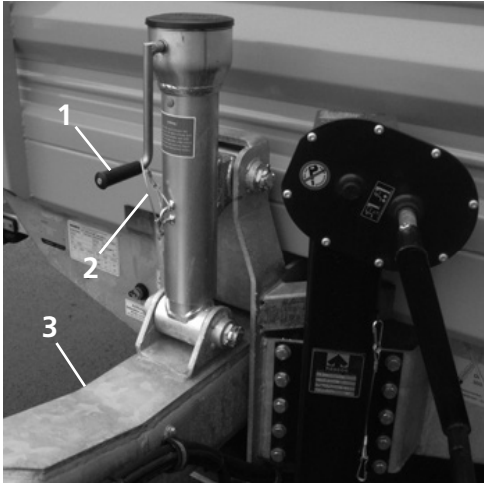

Drawbar height adjustment

- 1 Crank to adjust the elevation
- 2 Crank locking device
- 3 Drawbar

Release the crank locking device. Turn the crank to adjust the drawbar to the towing vehicle height. Insert the crank locking device again when you set up the drawbar to the desired height.

Do not change the connections of the height adjustment.

### 8.2 Extension and retraction of the jockey wheel or the supporting base

#### Danger to life!



**Danger!**

Supporting base or jockey wheel incorrectly raised or wound up. The supporting base or jockey wheel can be torn down and thrown away. People can be injured or killed, objects can be damaged.

**Make sure the supporting base or the jockey wheel is fully retracted for the journey.**

#### Jockey wheel



Jockey wheel

Pay attention to the crank lever, always ensure that the jockey wheel does not block the brake rod when is folding up. Wind the jockey wheel always completely up until is fully retracted.

#### Supporting base

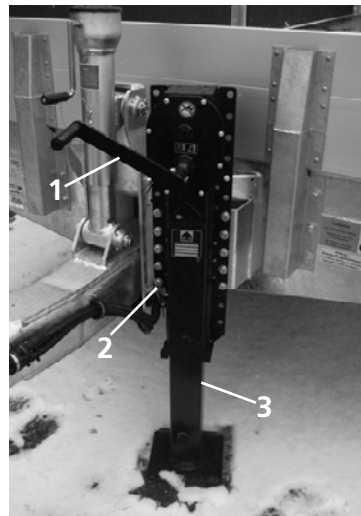

Supporting base

- 1 Crank
- 2 Locking device
- 3 Supporting base

To extent the supporting base, release the crank locking device. Wind the supporting base down. To retract the supporting base to the driving position, wind it using the crank upwards. Insert the crank locking device.

### 7.3 Coupling the trailer

Drive your towing vehicle to the trailer so the towing ring engages in the hitch of the vehicle. Pull the handbrake in the towing vehicle. Check the trailer is correctly coupled. Now connect the terminals of the trailer to the towing vehicle. Make sure to connect in the right order.



- 1 First, plug the power supply and the ABS or EBS connector of the trailer to your vehicle. Secure it by putting down the locking bracket.
- 2 Clean the sealing surfaces and sealing rings of the coupling heads of the compressed air with a clean cloth. Clean it in the towing vehicle as well as in the tractor.
- 3 Couple the compressed air line for the control system (yellow).
- 4 Couple the compressed air line for the supply (red).  
Check the connection between the trailer and the towing vehicle are properly connected and tight.  
Take the chocks away under the tyre. Plug these into the designated holder under the loading area. Release the spring brake in the HT 10xxxx and HT 11xxxx trailers. Do this by pressing the red button on the control panel.

#### Before every journey, check:

- The wheel chocks are secured.
- The connections for the electrical system and air pressure are properly connected.
- The lighting system is working.
- The air suspension bellow is not damaged.
- The brake system is working.
- The trailer is properly coupled.
- The spring bars of the supporting base are closed at the rear.
- The supporting base is folded up.
- The spring brake is released.
- The load is fastened properly.
- The overall weight, the nose weight and the axle loads are observed.
- The underrun protection is correctly installed and there is not damaged.

## 9 How do I couple and secure the trailer?

When you remove the air pressure lines the service brake of the trailer is automatically activate. Follow the sequence of your connections to distinguish.

- 1 Disconnect the compressed air hose for the supply (red) from the towing vehicle.
- 2 Disconnect the compressed air hose for the controller system (yellow) from the towing vehicle.



Pneumatic holder

Fasten the pneumatic holder on the drawbar. To do this, put the coupling head with the hole on the button. Turn the coupling head counter clockwise until it stops. Unplug

the connector for ABS or EBS and the electrical system. Plug these into the pneumatic hold on the drawbar.

#### Material damage!



#### Caution!

Handbrake when the brake is overheated. The brake discs can be damaged by the different cooling rates that occur in the braking process. At high temperatures the disc brakes expand slightly and press the brakes pad harder. When the brake is released, the pads could present irreparable damages.  
**Activate the handbrake when the brake is cold.**

Activate the spindle handbrake in the HT 50xxxx and HT 50xxxx-20S trailers.

In the trailers with spring brake, you should following the next step. Pull the red button on the brake control panel. Place the wheel chocks under the tyres. Uncouple the trailer. Drive the towing vehicle away.

## 10 How do I load and unload the trailer?

Fold down the supporting base for loading and unloading the trailer in the uncoupled state.

#### Danger to life!



#### Danger!

Loading and unloading the trailer. The supporting base at the rear is not folded down. The rear axle or the frame can be damaged.  
**Always support the trailer for loading and unloading.**

#### Danger to life!



#### Danger!

Loading and unloading of the trailer. The trailer is on loose ground for loading or unloading. The supporting base and the folding legs sink. Thus, the rear or the front is no longer supported. Thus the rear or front axle or the frame can be damaged.  
**Load and unload the trailer on a solid surface.**



#### Slip danger!

#### Risk of injury

Enter to the loading area with inappropriate footwear.  
The loading area can be slipper with soling or moisture. The person can be injured.  
**Enter the trailer only with adequate footwear.**

### Risk of injury



**Danger!**



**Sturdy shoes**

Entering and leaving the loading area.  
One can easily stumble at the entering or leaving area, because the loading zone doesn't offer support to climb at this area. Wrong footwear makes easier to stumble. The person can be injured.  
**Enter the trailer only with the adequate footwear. Always enter carefully, never hastily.**

### 10.1 Load distribution



**Danger!**

#### Danger to life!

Driving with a wrong load distribution. The trailer can skidding, this could cause personal injuries, death or property damage.  
**Distribute the load for the journey according to the valid laws and regulations.**

Distribute the load evenly and centered on the loading area of the trailer.  
You must obey the valid laws of the country in where you are transporting the load. Also you must follow all the applicable laws regarding the load protection.

### 10.2 Load protection

#### Danger to life!



Driving with unsecured loads. The load or load parts can be thrown outwards the trailer. People can be injured or killed.  
**Secure the load in every journey**

#### Danger!

The load must be properly secured. You must check this before and during the journey. Depending on the model, the load can be fastened to different points.

**HT 50xxxx, HT 10xxxx and HT 11xxxx**

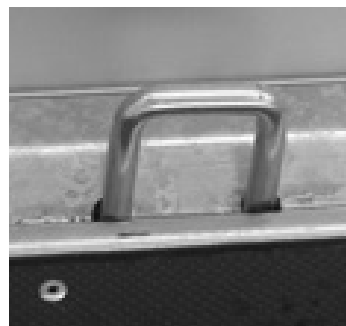

**Lashing shackle**

The HT 50xxxx, HT 10xxxx und HT 11xxxx trailers have integrated in both sides of the loading area a V-lashing rod. The number of lashing shackles depends of the length of the trailer. If you don not use the lashing shackles, they will lie completely in the V-lashing rod.  
Notice the maximum allowed load of the lashing brackets. The lashing shackle may be loaded up to 2000 daN. The lashing angle must be at least 30° to the loading floor. In addition, you must follow the valid rules for the load protection. Also you must obey any other law regarding the load property.

**HT 50xxxx-20S (accessories)**



**Lashing point**

The 50xxxx HT-20S trailers have lashing points integrated in the loading area. The number of lashing points will depend on the length of the trailer. They are suitable for a tensile load of 400 daN / kg.

### 10.3 Lowering/Lifting the supporting base

Use for your own security gloves when you operate the supporting base and the sidewalls.  
Loading and unloading the trailer on a solid surface.  
A second supporting base is available as an accessory for the right side of the trailer.

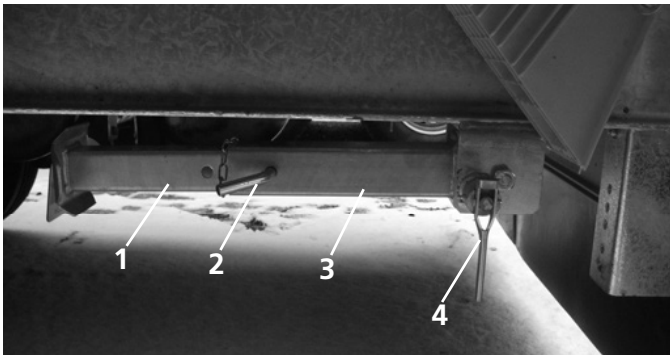

**Supporting base in driving position**

- 1 Bottom supporting base
- 2 Fastener bolt
- 3 Top supporting base
- 4 Lever



**Supporting base in support position**

Open the lever of the supporting base in the rear, until the supporting base folds down independently. Release the lever. If the supporting is in the correct position, the lever locks independently. Remove the safety pin from the fastener bolt. Pull the fastener bolt from the lower part of the supporting base. Place the supporting base slowly on a solid surface.

Insert the fastener bolt in the round holes of the supporting base and secure it with the safety pin. If this is not possible, raise the lower part so far that you can insert the fastener bolt.

### 10.4 Handling the sidewalls

#### **Risk of injury!**



**Caution!**

Opening and closing the folding doors. The fingers can be crushed between the door and the side posts when you open the lever.

**Take care when operates the sidewalls that you do not crimp their fingers.**

#### **Risk of injury!**



**Caution!**

"s when the trailer is loaded.

The sidewalls can jump up by the pressure which is exerted by the load and this can fall down.

**Open the sidewalls carefully when the load is against them.**

#### **Opening and closing the sidewalls**

Hold the sidewall when opening down to avoid that this jumps up. Open the sidewall locks. Fold the sidewall down.

To close the sidewalls you must fold the sidewalls up and close the locks.

In the HT 10xxxx and HT 11xxxx trailers the rear wall has a folding step.



**Folding step at the rear wall**

To fold the step down, pull it up and then fold it away the sidewall. Close the folding step before you fold the sidewalls up in the driving position. To close the step, fold it upwards and press it against the fixture down.

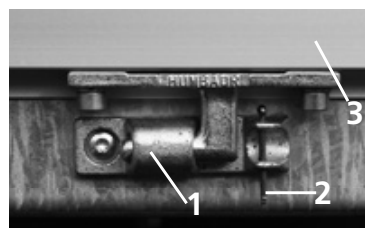

**Sidewall hinge**

- 1 Hinge
- 2 Safety pin (only front and rear walls)
- 3 Sidewall

To remove the sidewall hinge, remove the safety pin from the hinge (each sidewall hinge on the right outside). Open all levers of the sidewalls to be removed. Hold the sidewall at 90 ° angle to the position of the closed wall. Unhook the sidewall.

If you have removed all sidewalls, remove the corner posts. The assembly occurs in reverse order. Besides, it is noted that you must use a new protection pin if this is defective.

## 10.5 Handling the box structure

### Opening and closing the double folding doors

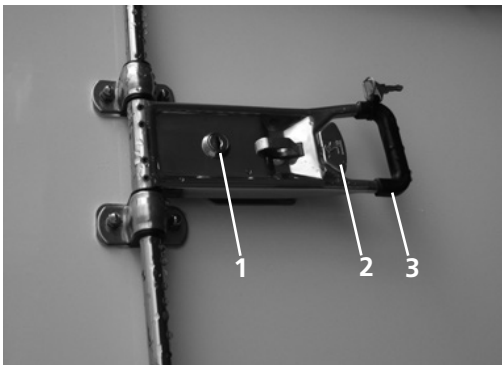

Door locking gear

- 1 Safety lock
- 2 Pressure relief device
- 3 Handle

Hold the double folding doors while opening firmly to prevent that these jump up. Open the door locking gear. Unlock in addition the lock of the door locking gear. Press the pressure relief device and raise the handle, until this stands in 90° angle to the double doors. Open the double door and bring the handle back in his original position. Secure the open doors using the door clamps.

To close the double doors you have to close first the left one and then the right door. Close the door locking gear. Make sure that the locking and the pressure relief devices engage correctly. Close the door locking gear for every journey.

## 10.6 Loading the trailer



**Risk of injury**

**Slip  
Danger!**

Enter to the loading area with inappropriate footwear.

The loading area can be slippery with soiling or moisture. The person can be injured.

**Enter the trailer only with adequate footwear.**

### Risk of injury



**Caution!**

Entering and leaving the loading area. One can easily stumble at the entering or leaving area, because the loading zone doesn't offer support to climb at this area. Wrong footwear makes easier to stumble. The person can be injured

**Enter the trailer only with the adequate footwear. Always enter carefully, never hastily.**



**sturdy  
shoes**

Provide the correct load distribution and protection according to the valid regulations of the load protection. Follow the allowed gross weight of the trailer.

### On the loading area

Load the trailer in such way that the load does not affect the front wheel area. With non observance of the load, it can damage the towing vehicle while driving. Provide the correct load distribution and protection according to the valid regulations of the load protection. Follow the allowed gross weight of the trailer.

### Loading gravel

Check the sidewalls are closed before you load the trailer with gravel. Now you can top up the load. Provide a correct charge distribution and load protection according to the valid regulation on the load protection.

## 10.7 Unloading the trailer



**Risk of injury!**

**Slip  
Danger!**

Enter to the loading area with inappropriate footwear. The loading area can be slipper with soling or moisture. The person can be injured.  
**Enter the trailer only with adequate footwear.**

**Risk of injury**



**Caution!**

Entering and leaving the loading area. One can easily stumble at the entering or leaving area, because the loading zone doesn't offer support to climb at this area. Wrong footwear makes easier to stumble. The person can be injured

**Enter the trailer only with the adequate footwear. Always enter carefully, never hastily.**



**sturdy shoes**

**Danger to life!**



**Danger!**

Unloading the trailer with a crane. The fastening of the load breaks and the load falls down.

**Never step under floating loads.**

**Danger to life!**



**Danger!**

The air suspension bellow at the rear is not ventilated.

The rear axles are overloaded and damaged. This can lead to an accident.

**Before departure, always ventilate the air suspension bellow.**

**10.8 Handling the underrun protection**

The 10xxxx HT and HT 11xxxx trailers are equipped with a standard underrun protection. Use for your own protection gloves when operating the underrun protection.

**Danger to life!**



**Danger!**

Driving with underrun protection folded up. The underrun protection is not in the driving position. This may lead to accidents. People can be injured or killed, objects can be damaged.

**Set the underrun protection in the driving position for every journey**

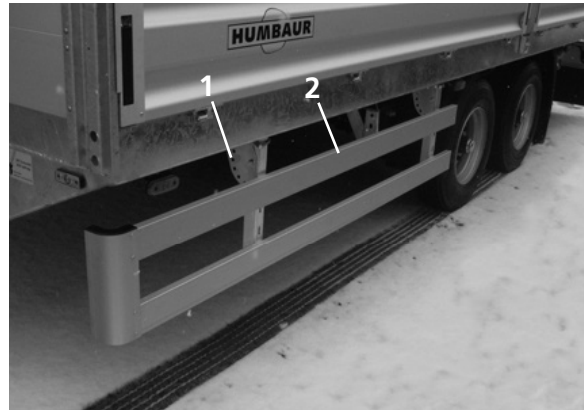

Underrun protection in driving position

- 1 Adjustable grid
- 2 Underrun protection



Setting the underrun protection with a bolt

To adjust the underrun protection pulls the bolt of the side guard from the adjustable grid.

Fold the underrun protection outwards up to the desired position. Attach the bolt again in the adjustable grid. Attach the hinged underrun protection for each trip in the driving position.

**11 How do I maintain the trailer ?**

**Material damage!**



**Caution!**

When cleaning with a pressure cleaner. Parts of the trailer can be damaged by too close a distance, too high a pressure or too high a temperature.

**Observe the values specified in the following paragraph.**

Check that the lubrication points have been greased until the grease emerges. If not, grease them. Use a pressure cleaner with a maximum pressure of 5-10 bar. Take care that the water temperature does not exceed a maximum of 80° C. Maintain a minimum distance of 70 cm. Note that the following parts must not be sprayed.

- All electrical parts
- The tyres
- The parts of the air compressed system

Do not use any abrasive, acid or alkali-containing cleaning agents, as these can destroy the surface coating.

Carefully clean the parts with a pressure cleaner after journeys on roads on which salt has been scattered or after transporting fertilisers or other acid or salt-containing substances. Acids, salts and certain chemicals can attack the surface coating of the parts and destroy its properties.

### **Characteristics of individual surfaces**

#### **Characteristics of galvanised parts**

Galvanised parts lose their bright finish with time. This effect is desired, as the rust protection characteristic of galvanisation only takes effect in the oxidised state. Galvanised surfaces can be protected by treating them with a commercially available corrosion protection agent.

#### **Characteristics of aluminium wall sides**

To remove strong soiling and get the aluminium shine  
Use the original Humbaaur cleaner or equivalent cleaning agents.

## 12 How do I service the trailer?

### 12.1 Maintenance regime

Maintenance includes regular checks of individual components, followed by taking appropriate action. Even the lubrication of individual components is a regular maintenance activity. The frequency should be adapted to suit the conditions of use. Defective parts of the trailer must be replaced with original parts.

The trailer must be checked after 50,000 km or after 12 months by a reliable expert on service.

The examination of the roadworthy condition of the vehicle should be realized by an expert who provides a faultless result according to the laws of the respective country.

The following details refer to normal use with a maximum of 50,000 km driven per year. Instructions for these can be found in the following subsections.

Maintenance work	After the first one:			each	
	50 km	500 km or first load drive.	5.000 km	5.000 km (fortnightly)	10.000 km monthly
Check wheel nuts tightness	x	x	x	x	
Check all security screws for tightness and tighten if is necessary		x	x	x	
Check tyre pressure and tyre wear			x	x	
Brake system: Maintenance work		x	x	x	
Check brake adjustment or setting.		x	x	x	
Electrical system: Maintenance work					x
Line filter coupling heads				x	
Lubricate the drawbar			x	x	
Other lubrication work (axle, handbrake, tilt cylinders, ...)					x
Check towing ring for wear					x
Examine frames and construction parts for tears and damages					x

Damaged parts must be repaired or replaced.

All other maintenance work must be carried out regularly every 6 months by a specialist.

#### Professional maintenance list:

- Brake System
- Wheel Bearing
- Axle
- Tyres
- Electrical equipment
- Compressed air system
- Lashing points
- Towing ring
- Accessories (if there is any)

## 12.2 Axle

See operating manual of the axle manufacturer. The guide can be found on the website of the manufacturer ([www.al-ko.de](http://www.al-ko.de), [www.bpw.de](http://www.bpw.de) und [www.gfachsen.de](http://www.gfachsen.de)) Check the axle Type on the axle Type plate. The axle plate is located in the center of the axle. Follow the instructions for this Type.

## 12.3 Towing ring

Lubricate the towing ring with commercial standard grease. The ring must be greased always to prevent increased wear.

Check the towing ring for wear. The wear of a ring with nominal diameter of 40 mm could be at maximum 1.5 mm and with a nominal of 50 mm maximum 2.5 mm. Beyond this limit, you must replace the wear jacket of the towing ring.

## 12.4 Lubrication of the drawbar

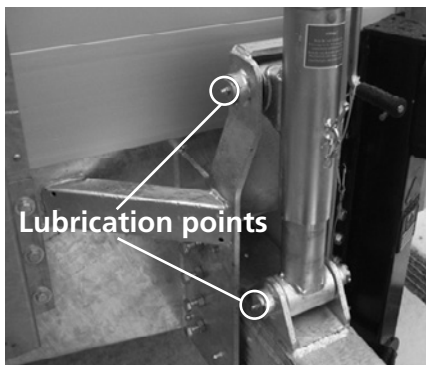

**Drawbar lubrication points**

Before lubricating, clean the lubrication nipples with a clean rag. Use available commercial grease for vehicles. Lubricate the drawbar with a grease gun on the grease nipples.



**Lubricating the drawbar**

Remove the cover of the drawbar to lubricate the height adjustment device of the drawbar. Lubricate the gear of the height adjustment device.

## 12.5 Lubrication of the folding legs

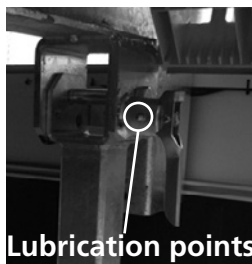

**Folding legs lubrication points**

Before lubricating, clean the lubrication nipples with a clean rag. Use available commercial grease for vehicles. Lubricate the folding legs with a grease gun on the grease nipples.

## 11.6 Lubrication of the supporting base



**Lubricating the supporting base**

Before lubricating, clean the lubrication nipples with a clean rag. Use available commercial grease for vehicles. Lubricate the supporting base with a grease gun on the grease nipples.



## 12.6 Maintenance of the compressed air system

### Replacing or cleaning the filter of the coupling heads

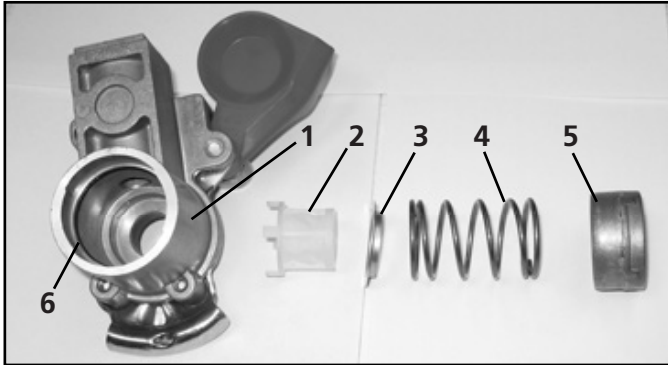

Disassembled coupling head

- 1 Housing
- 2 Filter
- 3 Metal ring
- 4 Spring
- 5 Cover
- 6 Gasket

Open the coupling head, pull the cover and turn it around 90° with a hexagonal Allen screw until it is separate from the housing. Take the spring, the metal ring and the filter from the housing. Clean the housing with a clean cloth. Now, clean the filter or replace it if it is too dirty or damaged. Check the gasket, if it is defective or completely absent you must replace it. Grease the gasket with some grease. For assembling use the metal ring with the edge down in the spring. Put the filter with the body down in the spring (picture: disassembled coupling head). Put the spring again in the housing. Place the cover on the opening housing. Press the cover until it stops and close it with a hexagonal Allen screw, by turning around 90°.

### Draining the brake system

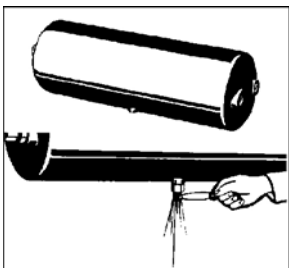

draining

## Danger to life!



**Danger!**

Draining the brake system.

The system is not drained.

There may be water in the system and in the worst case it could block the brake.

**Realize the maintenance service at the specified time.**

To prevent freezing of the compressed air system during the winter, we recommend using antifreeze. You need to drain all the air tanks on the trailer. The drain valves are installed below the center of the tanks. Pull the safety bolt of the draining valve to the side. Hold the bolt firmly, until there is not more condensation. Release the safety bolt. The drain valve closes. You must replace defective or leaking valves.

## 12.7 Tightening torque

Metric thread	Toque moment (Nm)		Metric thread	Torque moment (Nm)	
	8.8	10.9		8.8	10.9
M 5	5,5	8,1	M 20	425	610
M 6	9,6	14	M 20x1,5	475	980
M 8	23	34	M 22	580	820
M 8x1	25	37	M 22x1,5	630	900
M 10	46	67	M 24	730	1050
M 10x1,25	49	71	M 24x2	800	1150
M 12	79	115	M 27	1100	1550
M 12x1,5	83	120	M 27x2	1150	1650
M 14	125	185	M 30	1400	2000
M 14x1,5	135	200	M 30x2	1500	2150
M 16	195	290	M 36	2450	3500
M 16x1,5	210	310	M 36x2	2650	3780
M 18	300	430	M 42	3930	5600
M 18x1,5	340	485	M 42x2	4280	6050

Exception: wheel nuts with a torque moment of 290 Nm  
After dismantled completely, you must use new bolts, nuts and bolts with locking clamps.

## 12.8 Tyres

### Checking the tyres

Check the tyre pressure and the depth of tread. Take from the table below the right tyre pressure for the tyres of your trailer. If your tyres are not listed in the table, you should contact the tyre manufacturer.

Tyre pressure in bar (psi)			3,00 (44)	3,25 (47)	3,50 (51)	3,75 (54)	4,00 (58)	4,25 (62)	4,50 (65)				
Tyre marking	Pay-load index	single/ twin- pneumatic tyres											
215 R 14 C	112 110	E Z	1620 3065	1725 3270	1830 3470	1935 3665	2040 3860	2140 4050	2240 4240				
225/70 R 15 C	112 110	E Z		1750 3270	1830 3460	1935 3660	2040 3860	2140 4050	2240 4240				
Tyre pressure in bar (psi)			6,50 (94)	6,75 (98)	7,00 (102)	7,25 (105)	7,50 (109)	7,75 (112)	8,00 (116)	8,25 (120)	8,50 (123)	8,75 (127)	9,00 (131)
215/75 R 17,5	135 133	E Z	3520 6650	3630 6850	3730 7050	3840 7250	3940 7450	4050 7650	4150 7850	4260 8050	4360 8240		
235/75 R 17,5	143 141	E Z		4330 8180	4460 8420	4580 8660	4710 8900	4840 9140	4960 9370	5080 9610	5200 9840	5330 10070	5450 10300
Tyre pressure in bar (psi)			4,50 (65)	5,00 (73)	5,50 (80)	6,00 (87)	6,50 (94)	7,00 (102)	7,50 (109)	8,00 (116)	8,50 (123)	8,75 (127)	9,00 (131)
245/75 R 17,5	136 134	E Z	2690 5095	2930 5545	3160 5985	3390 6415	3610 6840	3835 7260	4050 7670	4265 8075	4480 8480		

Load capacity of the axle in kg with given tyre pressure

## 12.9 Changing the wheels

When changing tyres, you must pay attention to the following:

Note the direction of the wheels.

Check the air pressure.

Oil the wheels nuts threads before placing them (use any oil with molybdenum disulphide additive).

Make sure that the tyres have the same profile strength.

Secure the trailer with the wheel chocks from rolling away, and pull the parking brake.

Tighten the wheel nuts always crossed.

Wheel nut torque 600 Nm.

## 12.10 Plug connection

The trailers are standard equipped with a 15-pin plug in accordance to ISO 12098.



15-pin plug

Nr.	Function	cable cross section	Line colour
1	Left light indicator	1,5 mm <sup>2</sup>	yellow
2	Right light indicator	1,5 mm <sup>2</sup>	green
3	Rear fog light	1,5 mm <sup>2</sup>	blue
4	Ground connection	2,5 mm <sup>2</sup>	white
5	Left end-outline, running light, license plate illumination.	1,5 mm <sup>2</sup>	black
6	Right end-outline, running light, license plate illumination.	1,5 mm <sup>2</sup>	brown
7	Brake light	1,5 mm <sup>2</sup>	red
8	Reversing light	1,5 mm <sup>2</sup>	gray
9	Power supply 24 V	2,5 mm <sup>2</sup>	brown/blue
10	Sensor for brake pad wear indicator	1,5 mm <sup>2</sup>	brown/red
11	Pressure sensor of the spring brake	1,5 mm <sup>2</sup>	yellow/black
12	Lifting axle	1,5 mm <sup>2</sup>	pink
13	Ground connection for data line.	2,5 mm <sup>2</sup>	white/black
14	Data line	1,5 mm <sup>2</sup>	purple
15	Data line	1,5 mm <sup>2</sup>	orange

In addition, all trailers are equipped with an antilock braking system.



Antilock braking system plug

ABS trailer connection according to ISO 7638-1, ISO 7638-2			
Nr.	Function	cable cross section	Line colour
1	Positive solenoid valve KL 30	4 or 6 mm <sup>2</sup>	red
2	Positive Electrical system KL 15	1,5 mm <sup>2</sup>	black
3	Negative Electrical system KL 31b	1,5 mm <sup>2</sup>	yellow
4	Negative solenoid valve KL 31	4 or 6 mm <sup>2</sup>	brown
5	Warning device	1,5 mm <sup>2</sup>	white
6	CAN HIGH	1,5 mm <sup>2</sup>	white/ green
7	CAN LOW	1,5 mm <sup>2</sup>	white/ brown

As an accessory the trailer can be equipped with a 7-pin normal plug according to ISO 1185(black) and an additional 7-pin connector according to ISO 3731(white).



7-pin normal plug and 7-pin additional plug

7-pin plug according to ISO 1185 - black			
Nr.	Function	cable cross section	Line colour
1	Ground connection	2,5 mm <sup>2</sup>	white
2	Left end-outline, running light, license plate illumination	1,5 mm <sup>2</sup>	black
3	Left light indicator	1,5 mm <sup>2</sup>	yellow
4	Brake light	1,5 mm <sup>2</sup>	red
5	Right light indicator	1,5 mm <sup>2</sup>	green
6	Right end-outline, running light, license plate illumination	1,5 mm <sup>2</sup>	brown

7-pin plug according to ISO 3731 - white			
Nr.	Function	cable cross section	line colour
1	Ground connection	2,5 mm <sup>2</sup>	white/black
2	Not used	1,5 mm <sup>2</sup>	purple
3	Reversing light	1,5 mm <sup>2</sup>	blue

7-pin plug according to ISO 3731 - white			
Nr.	Function	cable cross section	line colour
4	Permanent positive power supply	2,5 mm <sup>2</sup>	brown/blue
5	Ground connection for the control module	1,5 mm <sup>2</sup>	orange
6	Power supply for ignition control switch	2,5 mm <sup>2</sup>	pink
7	Rear fog light	1,5 mm <sup>2</sup>	blue

Colours can differ with the given plugs.

## 12.11 Changing the lights

### Rear light and license plate light

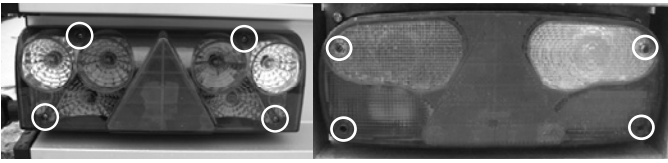

Rear light



License plate light

Remove the screws on the lamp. Open the cover. Remove the defective light from the socket. Insert the new light. Close the cover. Screw the cover back on. Make sure the light glass is seated properly, therefore the waterproof the rear light seals.

### Nozzle light

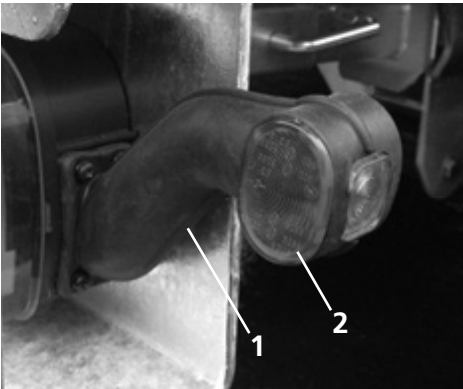

Nozzle light

- 1 Rubber mount
- 2 Housing

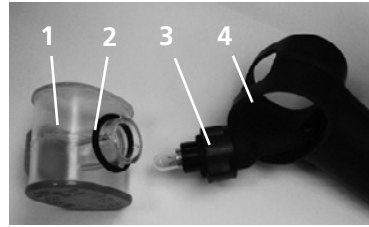

Nozzle light disassembled

- 1 Housing
- 2 Gasket
- 3 Plug with light
- 4 Rubber mount

Press the housing from the rubber mount. Turn the plug clockwise. Pull the plug from the housing. Turn the light around itself to unfasten. Change the light. Insert the plug into the housing and make sure to use the gasket. Turn the plug clockwise to lock it. Plug the housing into the rubber mount.

### Side marker lamp

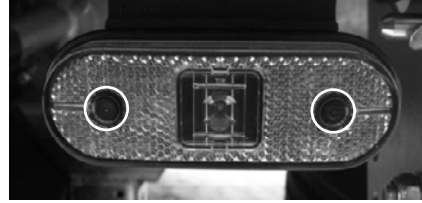

Side marker lamp

A defective LED lamp must be always replaced completely. Remove the screw to the side marker light. Remove the cover and replace the LED lamp. Put the cover again on the side marker lamp and tighten the screw.

## 13 Accessories

### 13.1 Duomatic-coupling

#### Product description

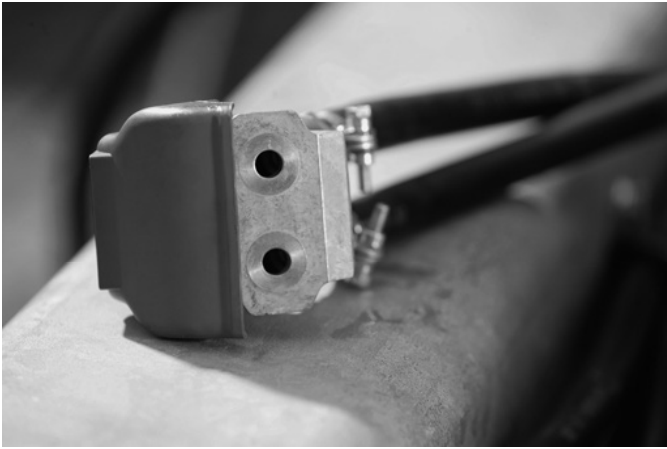

**Duomatic-coupling**

The Duomatic coupling connects the two air pressure tubes in a coupling.



**Pipe filter**

The pipe filters are located in the connections of the drawbar. The pipe filter ensures that no dirt can penetrate into the brake system.

#### Intended use

The Duomatic coupling may be used only with HT trailers manufactured by Humbaaur.

#### Use contrary to the intended

The Duomatic coupling may not be used with trailers that are not listed in the intended use.

#### General safety information

#### Danger to life!



Driving with dirty pipe lines. This may lead to failures in the braking system, and to fatal accidents  
**Clean the filter according the maintenance regulations.**

#### Danger!

#### What should I consider when using the duomatic coupling?

Clean the sealing surfaces of the coupling head and the counterpart on the towing vehicle with a clean cloth. When you disconnect the trailer, wrap the hose several times to the drawbar and push the Duomatic-coupling on the connection. Thus, the coupling is protected against soiling.

#### What changes in care and maintenance?

Clean the filter every 5000 km or every 3 months.

#### Disassembled pipe filter

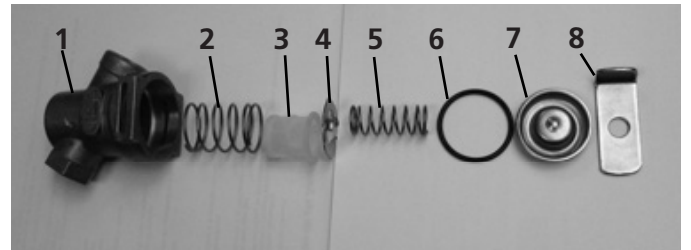

**Disassembled pipe filter**

- 1 Filter housing
- 2 Big spring
- 3 Filter
- 4 Intermediate plate
- 5 Small spring
- 6 Gasket
- 7 Cover
- 8 Bracket

#### Risk of injury!



The cover is held in position by a spring and can open upwards at a high speed.  
**Open the cover carefully.**

#### Danger!

Press with a screwdriver the cover of the filter case down and pull out the bracket. Take out the springs, the gasket, the intermediate metal and the filter of the filter housing. Clean the housing with a clean and dry cloth. Clean the filter soiling. If the filter is very dirty or damaged, then you must replace the filter.

Insert the filter in the big spring and use this in the filter housing. Grease the sealing gasket. If the sealing ring is damaged, you will have to replace it with a new one. Place the intermediate plate with the lugs up into the housing. Put the small spring on the lugs of the intermediate plate and put on the cover. Press the cover in the housing and push the bracket through the slots of the filter housing.

## Cleaning

### Material damage!



Do not use a pressure cleaner.

With the pressure of the water, the pipelines could be damaged.  
**Do not use a pressure cleaner to clean the accessories.**

### Caution!

Do not use any abrasive, acid or alkali-containing cleaning agents, as these can destroy the surface coating. Carefully clean the accessories after journeys on roads on which salt has been scattered or after transporting fertilisers or other acid or salt-containing substances. Clean the parts with an ordinary garden hose and a clean cloth or sponge.

## 13.2 Night park warning signs

### Product description

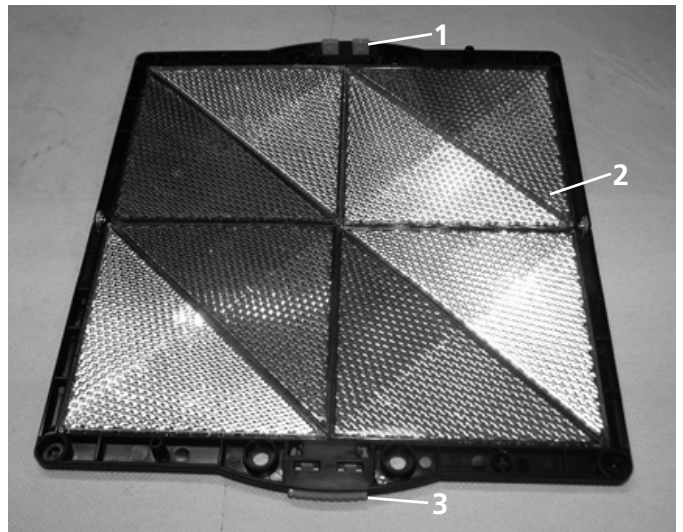

Open night park warning sign

- 1 Locking device
- 2 Warning sign
- 3 Pressure relief device

The night parking warning signs are in front and rear on the left side of the trailer attached. The night parking warning signs must be folded up for the ride.

### General safety information

#### Danger to life!



#### Danger!

Warning signs are not closed for the journey.  
The warning sign can cover the rear lights. This may lead to accidents. People can be injured or killed, objects could be damaged.  
**Close the night park warning signs before the journey begins.**

#### Danger to life!



#### Danger!

Warning signs are not cleaned.  
The night park warning signs are so dirty that they are not recognised in darkness any more. This may lead to accidents. People can be injured or killed, objects could be damaged.  
**Clean the night parking warning signs from the soiling.**

### Material damage!



The night park warning signs are not closed for the journey.  
The night park warning signs can be damaged.  
**Close the night park warning signs before the journey begins.**

### Caution!

#### How do I use the night parking warning signs?

To open the warning signs press the pressure protection and fold down at the same time the warning sign.  
To close the warning signs you fold this upwards, until the pressure protection engages.

#### What changes in care and maintenance?

### Material damage!



pressure cleaner.  
By the pressure of the water the reflective coating of the night park warning signs can chip off.  
**Do not use a pressure cleaner to clean this accessory.**

### Caution!

Do not use any abrasive, acid or alkali-containing cleaning agents, as these can destroy the surface coating.  
Carefully clean the accessories including the night park warning signs after journeys on roads on which salt has been scattered or after transporting fertilisers or other acid or salt-containing substances. Clean the parts with an ordinary garden hose and a clean cloth or sponge.

## 13.3 Spare wheel holder

### Product description

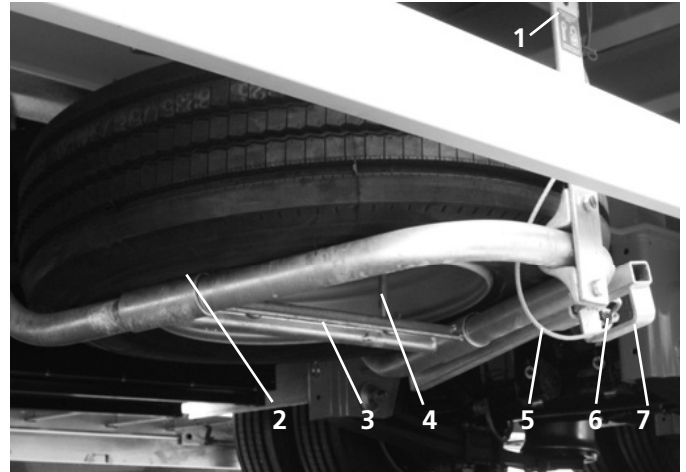

Spare wheel holder

- 1 Sealing
- 2 Spare wheel
- 3 Cross beam
- 4 Over-arm of the rim
- 5 Safety cord
- 6 Clipper
- 7 Handle

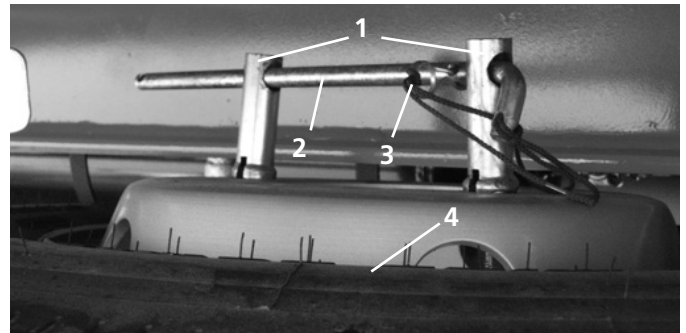

Mounting the spare tyre in the holder

- 1 Rim protection
- 2 Safety rod
- 3 Clip connector
- 4 Spare wheel

The spare wheel holder is mounted under the loading area. It is intended for mounting and transporting the spare wheel.

### Intended use

The spare wheel holder may be used only with HT trailers manufactured by Humbaur. The spare wheel holder must transport only wheels.

### Use contrary to the intended

The spare wheel holder should not be used with trailers that are not listed in the intended use.

## General safety information

### Risk of injury!



If the holder is opened. If the holder does not closed properly, the hold drops down easy and can hurt the operator there.  
**Hold the spare wheel holder when you open it.**

**Caution!**

### Danger to life!



If the holder is not closed with a clip connector or a padlock. The spare wheel holder can open during the journey and be broken off. This can lead to fatal accidents.  
**Close the spare wheel holder by the provided spring clip or a padlock.**

**Danger!**

### Danger to life!



If the spare wheel holder is not secured. The handles stands out at the side of the trailer and can lead to accidents.  
**Take the handle and always secure it with the clipper of the spare wheel holder.**

**Danger!**

### Material damage!



Tightening the rim protection. The rim protection is too tight. Thus, the rim is damaged.  
**Tighten the wheel wit a maximum of 80 Nm.**

**Caution!**

## How do I use the spare wheel holder?

### Open and close the spare wheel holder.

Open the clipper in the handle of the space wheel holder. Pull the handle. Hold the spare wheel holder using the handle in its position and open the sealing. Let down the spare wheel holder. Pull the clip connector from the safety rod. Open the rim protections by unscrewing the safety rod. Remove the spare wheel.

To close the spare wheel holder, lift this using the handle, so you can close the sealing. Push the handle back. Secure the handle with the clipper.

### Attaching the spare wheel in the spare wheel holder

Lift the spare wheel in the spare wheel holder. Insert the protection rims from below through the holes in the internal cross beam. Screw on the rim protection. Make sure that you thread the bent ends of the rods in the outer holes of the cross beam. Screw it with a maximum torque of 80 Nm.

### Danger to life!



If the spare wheel. The rim protection is not secure. It can come loose and the spare wheel can get lost. This can lead to accidents. People can be injured or killed.  
**Secure the rim protection.**

**Danger!**

Protect the rim protection with the safety rod. Put the clip connector in the drillings of the safety rod.

## What changes in care and maintenance?

### Material damage!



If you use a high pressure cleaner. The trailer can be damaged if you applied too much pressure or too close, also with high temperature.  
**Keep the specified value.**

**Caution!**

Use a pressure cleaner with a maximum pressure of 5-10 bar. Take care that the water temperature does not exceed a maximum of 80° C. Maintain a minimum distance of 70 cm.

Do not use any abrasive, acid or alkali-containing cleaning agents, as these can destroy the surface coating. Carefully clean the parts and the accessories with a pressure cleaner after journeys on roads on which salt has been scattered or after transporting fertilisers or other acid or salt-containing substances. Acids, salts and certain chemicals can attack the surface coating of the parts and destroy its properties.



## 13.4 Fire extinguisher box

### Product description



Fire extinguisher box

- 1 Fire extinguisher box
- 2 Fire extinguisher box lock
- 3 Document case

The fire extinguisher box is suitable for 6 kg of fire extinguishers. The fire extinguisher box is mounted on the front wall of the Tandem platform trailer.

### Intended use

The fire extinguisher box is intended only for the transporting fire extinguishers.

### Use contrary to the intended

Transportation of goods which are not listed in the intended use.

### General safety information

#### Danger to life!



Completely fire extinguishers box closed. The fire extinguisher box can open during the journey and the content can fall out.

**Check before every ride that the storage box is closed.**

**Danger!**

#### Risk of injury!



**Danger!**

Fire extinguisher box.

The fire extinguisher is not secured in the box and falls out when you open the box. The operator could be injured if things may be damaged.

**Secure the fire extinguisher with the properly protection.**

### How do I use the fire extinguisher box?

Open the locks of the fire extinguisher box. Open the locks levers. Loose the protection, with which the fire extinguisher is secured in the box. Now you can take the fire extinguisher. To use it you must follow the instructions on the extinguisher. For the trip, set the fire extinguisher in the box. Secure the extinguisher. Close the box properly.

### What changes about care and maintenance?

#### Material damage!



**Caution!**

High pressure cleaner

The trailer can be damaged if you applied too much pressure or too close, also with high temperature.

**Keep the specified value.**

Use a pressure cleaner with a maximum pressure of 5-10 bar. Take care that the water temperature does not exceed a maximum of 80° C. Maintain a minimum distance of 70 cm.

Do not use any abrasive, acid or alkali-containing cleaning agents, as these can destroy the surface coating. Carefully clean the parts and the accessories with a pressure cleaner after journeys on roads on which salt has been scattered or after transporting fertilisers or other acid or salt-containing substances. Acids, salts and certain chemicals can attack the surface coating of the parts and destroy its properties.

## 13.5 Plastic toolbox

### Product description



Plastic toolbox

The toolbox is mounted under the loading area and is used for storing small parts, e.g. Tools.

### Intended use

The tool box is designed to transport tools. The tool box may be filled up 50 kg.

### Use contrary to the intended

The tool box should not be filled above the maximum load.

### General safety information

#### Risk of injury



Toolbox.

In the journey objects which were transported in the toolbox are slipped. When you open the cover the objects can fall out and injured the operator.

**Open the tool box carefully.**

**Danger!**

### How do I use the tool box?

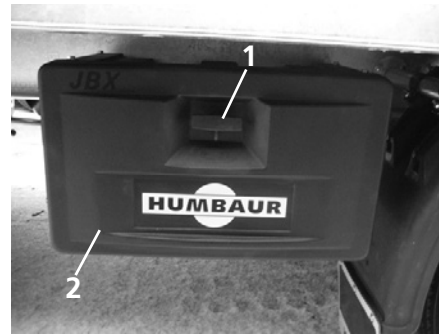

Toolbox

- 1 Handle
- 2 Toolbox

Open the tool box, by turning the handle vertically and pull the lid toward you.

Close the toolbox by closing the lid and rotate the handle in the horizontal position.

### What changes in care and maintenance?

#### Material damage



pressure cleaner.

The tool box consists of plastic and is not robust enough to be washed directly with a pressure machine.

**Do not clean the tool box with a pressure cleaner.**

#### Caution!

Do not use any abrasive, acid or alkali-containing cleaning agents, as these can destroy the surface coating. Carefully clean the accessories including the tool box after journeys on roads on which salt has been scattered or after transporting fertilisers or other acid or salt-containing substances. Clean the parts with an ordinary garden hose and a clean cloth or sponge.

## 13.6 Curtainsider Structure

### Product description



Tandem platform trailer with HT Curtainsiders structure

The curtainsider structure has a rear door, a lateral tarp which can be opened to the front and a sliding roof which can be drawn up in the entire length of the trailer. With the curtainsider the tarp is fastened using clamps that are attached to the outside frame profile.

### Intended use

The Curtainsider structure must be used only with the tandem-platform trailers manufactured by Humbaur GmbH.

### Use contrary to the intended

The Curtainsider structure should not be used with trailers that are not listed in the intended use.

### General safety information

#### Danger to life!



**Danger!**

When you open the tarp, it can be slipped or inadequately secured cargo may fall from the trailer and injured people. **Before opening the tarp clamps you must check that no load can fall from the trailer down.**

#### Danger to life!



**Danger!**

The corner posts are not correctly tightened with the nut in the tension rod. During the journey wind can penetrate into the trailer. The trailer can skid. People can be injured or killed, objects could be damaged.

**Attach the tension rod properly, tight the nut correctly in the corner profiles.**

#### Danger to life!



**Danger!**

doors.

The load pressure against the rear wall can open the door, load parts can fall down and injured people.

**The rear doors must be opened with caution, open one fastener of the doors. Remove the pressure of the rear doors while the second fastener is closed.**

#### Danger to life!



**Danger!**

doors.

Open the doors without securing them. They can swing around and cause accidents. People can be injured or objects damaged.

**Secure the open doors properly.**

#### Danger to life!



**Danger!**

roof.

The sliding roof is not fastening completely. Wind can penetrate into the trailer. The trailer can skid. This can lead to accidents. People can be injured or killed, objects could be damaged.

**Close properly the sliding roof, engage the locks on both sides.**

### Risk of injury!



**Danger!**

rong position.  
If the lever is not properly secure and placed, it can cause personal injuries or property damage.  
**Before the journey begins make sure that the ratchet level is in the correct position.**

### Risk of injury!



**Danger!**

posts.  
Opening the side posts with inserted boards. The boards can fall down and injured people.  
**Before opening the boards make sure that the boards have been removing.**

### Risk of injury!



**Danger!**

g the rear doors when there are persons or objects in the swing area. These persons may be injured or objects can be damaged.  
**Take care when opening and closing the rear doors that are not persons or objects in the swing area.**

### How do I use the Curtainsiders structure?

#### Handling the curtainsider

The curtainsider can be operating using a tension ratchet. The vertical tension is applied with the tarp clamps that are attached to the tarp.  
The tarp can be opened from the back using the aluminium profiles.

### Risk of injury!



**Danger!**

boards.  
Climbing above the tyres or other parts of the trailer instead of using a ladder to install the tilt boards increase the risk of fall down.  
**Use a ladder to install the tilt boards.**

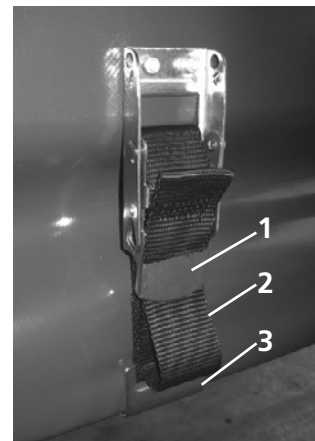

Tarp clamp

- 1 Flap
- 2 Tension belt
- 3 Hook

### Risk of injury!



**Danger!**

ards.  
The tilt boards under tension can jump out of the plugs and injured people.  
**Before removing the boards, eliminate the tension or pressure that the load may be applied on the boards.**

To open the tarp clamp you must pull the flaps of the clamps upwards. Release the hook and the tension belt. Now you can dismount the hooks down out of the frame profile.

### Risk of injury!



**Danger!**

posts.  
The posts can jump out while opening by load pressure with a big force and injured the operator.  
**Before opening the side posts remove the existing load pressure.**

To close the hooks, attach the hooks of the tarp clamp in the lower frame profile of the trailer. Pull the tarps clamp down on the outside frame profile and tighten it with the hook and the clamps in the profile.  
After mounting the hooks pull the tension belt in the turnbuckle down. Simultaneously press the flap down. This must engage under slight pressure and audibly engage in the holder.

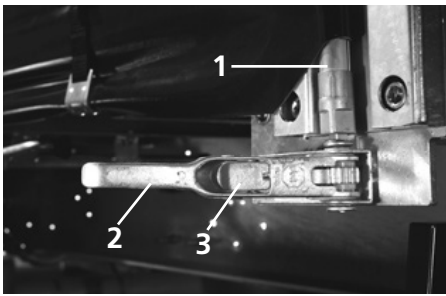

**Tension ratchet**

- 1 Tension rod
- 2 Tension ratchet
- 3 Protection flap

Before releasing the ratchet tension you must release all the tarp clamps of the tarp.

To open the tension ratchet at the rear of the trailer, press the protection flap inwards and fold the tension rod to the back, until this automatically unlocks. Remove the tarp by rolling the tarp from the tension rod.

Pull the tarp over the loop at the rear of the trailer upwards and put up the tension rod from the tension ratchet. Once you have posted the tension rod from the upper lock you can mount the tarp from the back to the front.

## Open the rear doors



**Rear view of the HT with curtainsider structure**

- 1 Folding door
- 2 Door latch
- 3 Door locking gear
- 4 Ladder
- 5 Door check strap

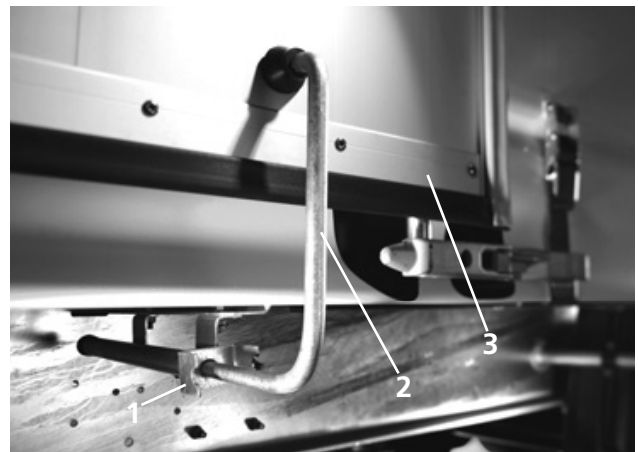

**Door check strap**

- 1 Bracket for the door check strap
- 2 Door check strap
- 3 Folding door

The commercial trailer HT with curtainsider structure is equipped with 2-rear folding doors and two door locking gears.

These doors can be opened 270°. In the open state the doors have in each side a clamp to secure them.

## Closing the curtainsider

### Risk of injury!



**Danger!**

rong position

If the lever is not properly secure and placed, it can cause personal injuries or property damage.

**Before the journey begins make sure that the ratchet level is in the correct position.**

Close the rear end of the tarp. Connect the upper end of the rear tension rod on the upper lock. Insert the lower end of the tension rod in the square profile of the tension ratchet. Make sure that you plug the tarp precisely and completely on the square profile. Now you can tight the tarp using the tension ratchet with the ratchet lever. After the clamping process, you must fold the ratchet lever completely inwards.

### Danger to life!



**Danger!**

doors.

The load pressure against the rear wall. When the door is opened, parts of the load can fall down and injured people.

**The rear doors must be opened with caution, open one fastener of the doors. Remove the pressure of the rear doors while the second fastener is closed.**

### Danger to life!



**Danger!**

doors.

Open the doors without securing them. They can swing around and cause accidents. People can be injured or objects damaged.

**Secure the open doors properly.**

### Risk of injury!



**Danger!**

g the rear doors when there are persons or objects in the swing area. These persons may be injured or objects can be damaged.

**Take care when opening and closing the rear doors that are not persons or objects in the swing area.**



**Rear door lock**

Open the right folding door first. To do this open the internal lock by pressing the lever and releasing the door locking gear. If there isn't any load pressure against the door, do the same procedure to open the outer door locking gear. Open the door completely and secure it with the door clamp. Pull the door clamp from his neutral position outwardly and turn it 90° upward. The tension in the clamp keeps the doors open.

Do the same procedure with the left door.

### Closing the rear doors

To close the rear doors, close the left door first.

Unlock the left door, by pulling the door clamp away and rotate it 90° downward. Arrest the door clamp in the fixtures under the loading area.

Close the left door. Make sure that the upper door latch is hooked in the flap before the door locking gear is closed. Close both door locking gears at the same time. Make sure that the locks snap properly.

Proceed with the right rear door in the same way.

Check before the driving begins that all door locking gears are properly closed.

### Ladder



**Extended ladder**

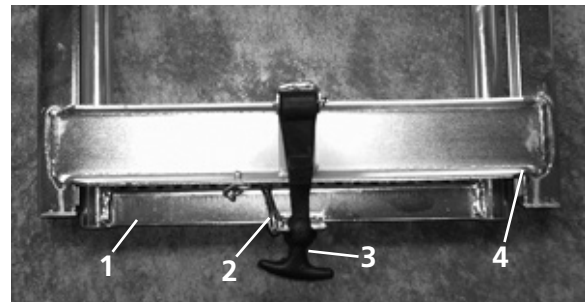

**Locking device**

- 1 Ladder
- 2 Clip
- 3 Lock
- 4 Guidance

The ladder is located on the right rear of the trailer. The trailer can be accessed using the ladder. Release the clip. Put the locking up the ladder. Pull the ladder out and fold it down until it stops. Now you can enter to the trailer using the ladder.

After leaving the trailer, fold the ladder up and slide it completely into the lead. Tighten the lock and attached simultaneously in the ladder. Attach the clip on the ladder.

## Opening the sliding roof



### Open sliding roof

To load and unload the trailer with a crane, the trailer is equipped with a sliding roof. The sliding roof is opened using a drawbar. The rear doors must be opened in order to open the slide roof.

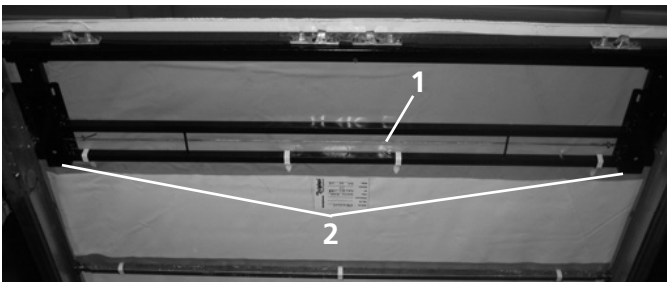

### Adjusting the slide roof

- 1 Connecting rope of the locking
- 2 Lock

Press the end piece of the roof upwards using a drawbar. Unlock the slide roof with the drawbar. To do this, you hang a hook on the drawbar and then pull the connecting cord down. Thus, the slide roof is unlocked. Afterwards you hang the hook up in the external ring on the roof and pull the slide roof forwards. Slide the roof until it is completely open and engages in the front locking

## Closing the sliding roof

### Danger to life!



### Danger!

Closing the sliding roof. The sliding roof is not fastening completely. Wind can penetrate into the trailer. The trailer can skid. This can lead to accidents. People can be injured or killed, objects could be damaged.

**Close properly the sliding roof, engage the locks on both sides.**



### Outer ring

Hang a hook in the outer ring and pull the roof back with a hitch, so it frees itself from the front locking. Now you can tighten the roof. Slide the roof until it engages into the left and right locks correctly at the rear.

If the slide roof is not correctly engaged, the end piece of the roof does not close completely. In this case, you can pull the slide roof with the external ring on the right side or with the one in the left side until the roof locks completely. Pull the end piece down using the drawbar. Now, the rear doors can be closed.

### Tilt boards



### Wood-tilt boards

- 1 Wood boards
- 2 Plug

### Risk of injury!



**Danger!**

boards.

Climbing above the tyres or other parts of the trailer instead of using a ladder to install the tilt boards increase the risk of fall down.

**Use a ladder to install the tilt boards.**

### Risk of injury!



**Danger!**

posts.

Opening the side posts with inserted boards. The boards can fall down and injured people.

**Before opening the boards make sure that the boards have been removing.**

### Risk of injury!



**Danger!**

boards.

The tilt boards under tension can jump out of the plugs and injured people.

**Before removing the boards, eliminate the tension or pressure that the load may be applied on the boards.**

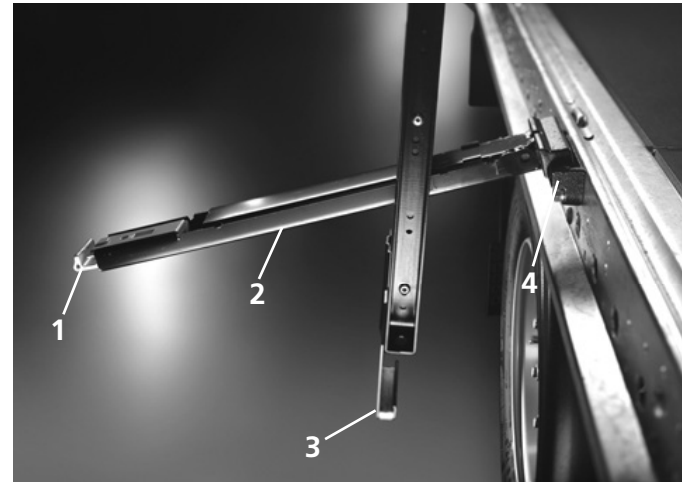

**Unlocked side post**

- 1 Locking device
- 2 Swing lever
- 3 Bracket
- 4 Post plug

Press for opening the posts the locking device down. Fold the swing lever outwardly, thus the side posts lowers itself a little. Put up the bracket from the frame. If the lever is tilted approximately 90°, you can put up the swing lever from the post plug on the chassis. Now the post is completely unlocked and can be moved. Lock the side posts after you adjust them to avoid damages while loading by a forklift or other loading vehicles.

There are wood and aluminium boards available for the curtainsiders. These are used to protect the tarp against denting.

Wooden boards are not suitable to secure the load. The aluminium boards have a clip and a nut, these increases the stability and the slats can be used as sidewalls. However the resulting sidewall can not secure the complete load. During the installation and removal of the tilt boards the next instructions must be followed:

- Use appropriate rise tools for the installation and removal of the boards.
- Do not step on the wheels, underride protection or other structure parts during the board's assembly.
- Make sure the tilt boards are firmly seat in the plug.

### Opening the side posts

### Risk of injury!



**Danger!**

posts.

The posts can jump out while opening by load pressure with a big force and injured the operator.

**Before opening the side posts remove the existing load pressure.**

### Locking the side posts

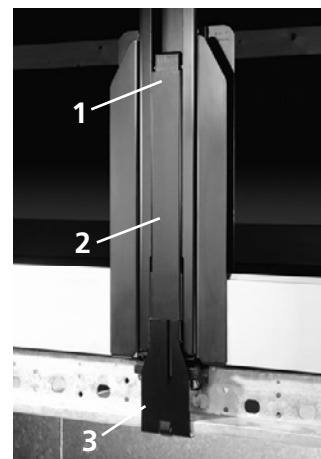

**locked side post**

- 1 Locking device
- 2 Swing lever
- 3 Bracket



### Risk of injury!



#### Danger!

Fastening the posts.  
Between the bracket, the chassis and the post plug, the fingers can be squeezed when you lock the side posts.  
**Hold the bracket always from the outside and not in the clamp area between the frame and the metal.**

Before locking the middle post push it to the suitable post plug. Swing the lever upwards and hang it in the post plug. Hold the bracket in the chassis and simultaneously move the swing lever upwards until it locks in the post.

### What changes in care and maintenance?

#### Material damage!



#### Caution!

Cleaning with a high pressure cleaner  
The trailer can be damaged if you applied too much pressure or too close, also with high temperature.  
**Keep the specified value.**

Use a pressure cleaner with a maximum pressure of 5-10 bar. Take care that the water temperature does not exceed a maximum of 80° C. Maintain a minimum distance of 70 cm.

Do not use any abrasive, acid or alkali-containing cleaning agents, as these can destroy the surface coating. Carefully clean the parts and the accessories with a pressure cleaner after journeys on roads on which salt has been scattered or after transporting fertilisers or other acid or salt-containing substances. Acids, salts and certain chemicals can attack the surface coating of the parts and destroy its properties.

## 13.7 Tarp and hoop

### Product description



HT with high tarp

- 1 Locking cord
- 2 Loop
- 3 Tarp clamps with holes

The high tarp is a structure with a tarp. The hoop frames are inserted into the corner posts of the trailer and consist of metal or wood frames as additional crossbar. The tarp is pulled over and connected at the corners with a synthetic cord on the flaps. Below the tarp are cramps to attach the tarp to the sidewalls of the trailer.

### Intended use

The high tarp must be used only with trailers manufactured by Humbaur GmbH.

### Use contrary to the intended

The high tarp must not be used with trailers or other devices not listed in the intended use.

### General safety information

#### Danger to life!



Do not drive without the rack, without the tarp.  
Parts of the rack can get lost in the journey. This can lead to injuries up to the death.

**Never drive without the tarp.**

#### Danger!



#### Danger!

#### Danger to life!

Drive with the tarp incompletely closed. The wind can blow into the trailer and make them roll. During the journey the wind can also release the flat cover and this could fly around. Both situations can lead to accidents. People can be injured or killed.

**Drive only with the tarp completely closed.**

**Danger to life!**



**Danger!**

Opening the tarp. When you open the tarp, it can be slipped or inadequately secured cargo may fall from the trailer and injured people. **Before opening the tarp clamps you must check that no load can fall from the trailer down.**

**Risk of injury!**



**Danger!**

Installing the tilt boards. Climbing above the tyres or other parts of the trailer instead of using a ladder to install the tilt boards increase the risk of fall down. **Use a ladder to install the tilt boards.**

**Risk of injury!**



**Danger!**

Removing the boards. The tilt boards under tension can jump out of the plugs and injured people. **Before removing the boards, eliminate the tension or pressure that the load may be applied on the boards.**

**Risk of injury!**

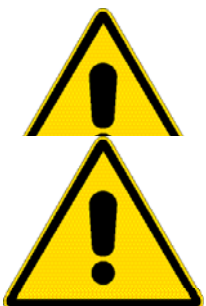

**Danger!**

Opening the side posts. The posts can jump out while opening by load pressure with a big force and injured the operator. **Before opening the side posts remove the existing load pressure.**

**Risk of injury!**

Opening the side posts.

Opening the side posts with inserted boards. The boards can fall down and injured people.

**Before opening the boards make sure that the boards have been removing.**

**Risk of injury!**



**Danger!**

Fastening the posts. Between the bracket, the chassis and the post plug, the fingers can be squeezed when you lock the side posts. **Hold the bracket always from the outside and not in the clamp area between the frame and the metal.**

**How do I use the tarp and hoop?**

**Attaching the tarp**

Drag the tarp on the rack. Make sure that the straight plates at the corners are on the outside.

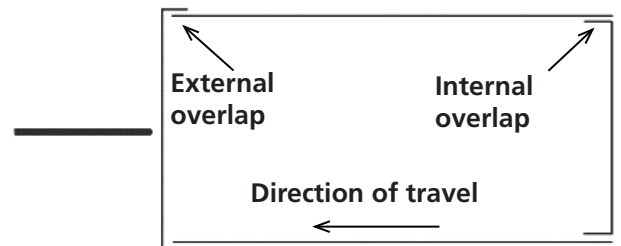

**Properly tarp installation**

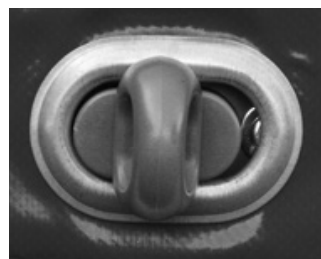

**Closed cramp**

Put the holes over the open cramps. Pull the cramps and rotated by 90°. Close all the cramps around the trailer. Close all the corners.

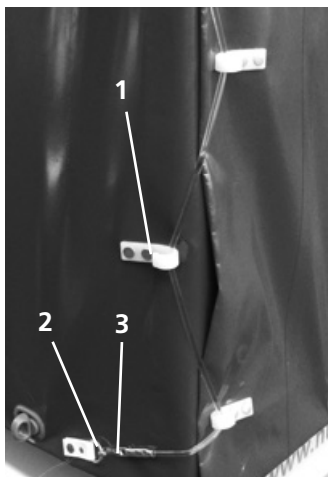

**Closed Corner**

- 1 Straight plates
- 2 Clipper
- 3 Connector

In order to closed the corners, use the cord from the top to the bottom always in the lateral side around the straight plates. If you have reached the bottom, then you hook the clipper below the connector. Do the same with the other corners.

If all the corners are closed, the trailer is closed.

### Open the tarp

Open the clipper on the corners and unhook it from the connectors. Solve the cord of the straight plates. Proceed also with the other corners. Open all the cramps on a side. Pull the tarp down form the cramps. Now the tarp is open in a side. To open the other sides just proceed in the same way.

### Opening the side posts

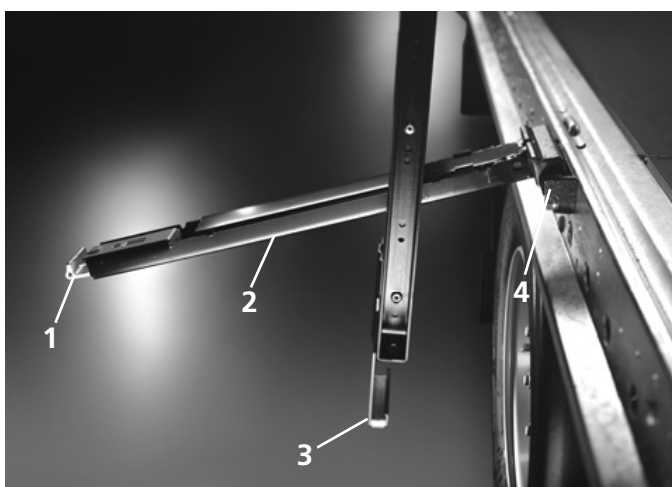

**Unlocked side post**

- 1 Locking device
- 2 Swing lever
- 3 Bracket
- 4 Post plug

Press for opening the posts the locking device down. Fold the swing lever outwardly, thus the side posts lowers itself a little. Put up the bracket from the frame. If the lever is tilted approximately 90 °, you can put up the swing lever from the post plug on the chassis. Now the post is completely unlocked and can be moved. Lock the side posts after you adjust them to avoid damages while loading by a forklift or other loading vehicles.

### Locking the side posts

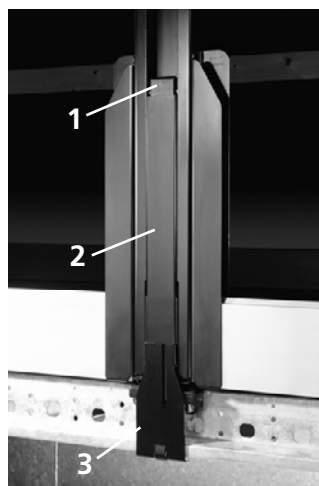

**Locked side post**

- 1 Locking device
- 2 Swing lever
- 3 Bracket

Before locking the middle post push it to the suitable post plug. Swing the lever upwards and hang it in the post plug. Hold the bracket in the chassis and simultaneously move the swing lever upwards until it locks in the post.

### Driving a trailer with tarp and hoop

Driving with high bodywork makes the trailer more susceptible to the wind. React accordingly the road characteristics. Especially on bridges or when a slip stream exists, the stability is compromised. Drive only with enclosed tarp, otherwise during the journey parts of the load could be throwing outwards. This can lead to accidents. People can be injured or killed.

## What changes in care and maintenance?

### **Danger to life!**



**Danger!**

Cleaning with an abrasive cleaner or a cleaner with an acid base. The flat cover could be damaged by cleaning with such agents. So it could break during the journey or just open. The wind can blow into the trailer and make it roll. The wind can also release the flat cover and it could fly around the air. Both situations can lead to accidents. People can be injured or killed.  
**Use only detergents suitable for the cover.**

### **Danger to life!**



**Danger!**

pressure cleaner. The flat cover will be damaged by the water pressure. So it could break during the journey or just open. The wind can blow into the trailer and make it roll. The wind can also release the flat cover and it could fly around the air. Both situations can lead to accidents. People can be injured or killed.  
**Do not clean the flat cover with a pressure cleaner.**

Do not use any abrasive, acid or alkali-containing cleaning agents, as these can destroy the material. Then it becomes porous and tears faster.

Carefully clean the parts after journeys on roads on which salt has been scattered or after transporting fertilisers or other acid or salt-containing substances, including the flat cover carefully. Acids, salts and certain chemicals can attack the material.

Clean with a normal garden hose and a clean cloth or sponge.

To remove strong soiling, use the original Humbaur aluminium and flat cover cleaning or the equivalent cleaning agents.

## **14 How do I dispose of the trailer or parts of the trailer?**

You must always dispose of the trailers and their parts in a proper manner. Always take the parts to a car recycling facility. The specialists at the recycling facility will dispose of them in a proper manner. The trailer or parts of the trailer must be disposed of in accordance with the legislation in force at the time of disposal.

## 15 What should I do in the event of a malfunction?

Malfunction	Possible Fault	Solution
The trailer is constantly braked.	The spindle brake has not been releasing.	Release the spindle brake.
	The brake system is not properly maintained.	Look for a garage and wait until the brake system is ready.
	Failure in the compressed air system.	Look for a garage.
	A brake drum is broken.	Look for a garage.
The spring loaded brake can not be release.	The compressed air system is leaking and the working pressure is not reached.	Look for a garage.
	The pressure in the reservoir is too low.	Connect the trailer to a towing vehicle.
The service brake can not be release.	The pressure in the reservoir is too low.	Connect the trailer to a towing vehicle.
	A brake drum is broken.	Look for a garage.
The trailer turns rightwards or leftwards during the journey.	The load is not evenly distributed.	Distribute the load evenly.
	The tyre pressure is irregular.	Fill up with air or let it down until the tyre pressure is evenly and properly.
	The load is not properly secure so it moves slowly.	Secure the load properly.
	The brake of one wheel is wrong engaged and brakes.	Look for a garage.
The trailer skids during the journey.	The tyre pressure is too high.	Release the pressure from the tyres until they have a normal tyre pressure.
	The driven speed is too high for the load and the road conditions.	Drive slowly.
	The main focus of the load is too high behind.	Move the main focus of the load further forwards.
The trailer rattles during the journey.	The load is not properly secure.	Secure the load properly.
	Cables or tubes are loose.	Drive into the nearest garage.
	The jockey wheel is not folded up and frees itself.	Fold up the jockey wheel and look for a garage where it can be fastened correctly.
The trailer is not in a horizontal position after the coupling.	The coupling height is not set correctly.	Adjust the coupling height.
	The support base is still folded down.	Fold up the supporting base.
The trailer squeaks during the journey.	The bearing of the towing ring has settled.	Lubricate the towing ring.
The trailer is not in a horizontal position after the coupling.	The lubrication points have not been adequately lubricated.	Lubricate all the lubrication points.
	The wheel bearing is defective.	Look for a garage.



## 16 Service and Warranty policy

### The warranty includes:

Defects that occur during proper use of the trailer as prescribed, or which are design related or can be attributed to material faults.

Repairs carried out during the guarantee period do not extend it.

The dealer is responsible for the guarantee as a contracting party.

### Requirements:

The maintenance instructions and regulations of the manufacturer, which are listed in this operating manual, must have been observed.

Original spare parts must be used for repairs.

Repairs must be carried out by a specialist garage.

### Defects must not be attributable to:

Non-compliance with the technical and legal regulations listed in this operating manual.

Improper use of the trailer or lack of experience on the part of the user.

Unauthorised alterations to the trailer, or fittings not approved by Humbaur GmbH invalidate the guarantee.

Non-compliance with the respective statutory regulations.

### The following are not defects:

Each trailer is a hand-made product. Despite the greatest of care, minor superficial scratches which have no effect on the intended use can occur during assembly.

Stress cracks in the surface (hairline cracks) caused during manufacture cannot be avoided. These hairline cracks have no effect on stability or the use of the trailer.

Gaps between the tailboard and the loading ramp.

Furthermore, polyester components are not 100% colourfast. Even here, UV and weather effects can cause fading.

Furthermore, it should be noted that rubber parts generally age as a result of UV influences, and the formation of cracks and fading of the surface is possible.

Parts coated by cathophoretic painting are not colourfast. They can fade as a result of UV irradiation.

Galvanised parts are not normally shiny but rather lose their bright finish after a short time. This is not a defect but rather a desired effect, as full protection against rusting of the metal is only guaranteed after oxidation. Wood is a natural material. Despite the most diverse types of processing and coating, it is therefore subject to natural, weather-dependent expansion and shrinkage, which can result in warping. Natural wood grain and irregularities are normal for this natural material and can appear on the surface.

Fading is also possible as a result of UV irradiation and weathering effects. A manufacturing tolerance is specified for the thickness of the wooden components used. Claims will not be accepted for deviations within the tolerance. As the

trailers are not generally insulated, temperature fluctuations can result in the formation of condensation under tarpaulins and polyester covers. In this case, adequate ventilation should be provided to prevent mould growth. Furthermore, the trailers are not 100% watertight. Water ingress at the doors, flaps and windows is still possible, even with extremely careful workmanship and the use of rubber seals.

### The warranty will expire:

If the regulations for operation, maintenance and inspection are not observed.

In the event of engineering alterations to the trailer.

In the event of independently undertaken fittings and superstructures that have not been approved by Humbaur.

In the event of overloading and improper use of the trailer.

If non original Humbaur spare parts are used.

If the safety instructions on the trailer are not observed.

If the service intervals are not adhered to, even for Humbaur-fitted parts such as the axle, brakes, overrun hitch, hydraulic systems, etc.

In the event of incorrect surface treatment of the materials used.

In the event of continued use of the trailer even though defects have already been detected and reported and the use has been prohibited by the manufacturer until repairs have been carried out.

In the event of continued use of the trailer with known defects where repair is not possible or is time-consuming or is only possible with significant additional expense and reduced function.

### The warranty does not include:

Expenditure for ongoing maintenance.

Costs that can be attributed to normal wear or even because the trailer has not been used for a long time.

Faults that can be attributed to not treating the trailer as specified.

Defects that can be attributed to the use of non original Humbaur spare parts.

Defects that can be attributed as a consequence of a repair not carried out by a specialist garage.

Defects that can be attributed to structural alterations or assembly work on the vehicle.

The manufacturer reserves the right to make design changes.

No liability is accepted for mistakes and printing errors.  
All illustrations are representative.  
Deviations and modifications are subject to the model type.  
Subject to change without notice.  
Copying prohibited.  
Printed in Germany.  
Version 07/20